

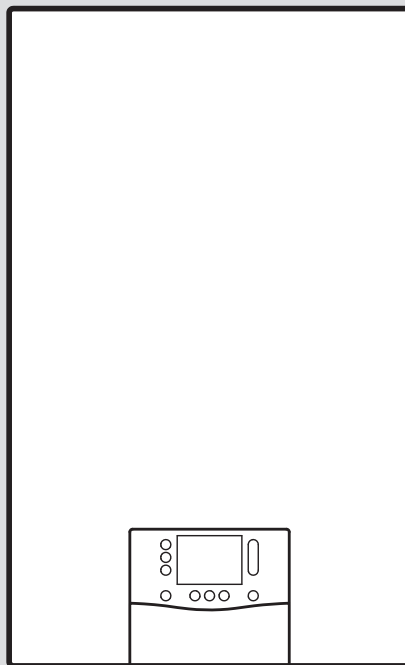

# ecoTEC plus

VU../VUW../VUI..



# Operating instructions

## Contents

<b>1</b>	<b>Safety</b> .....	<b>3</b>
1.1	Intended use .....	3
1.2	Qualification .....	3
1.3	General safety information.....	3
<b>2</b>	<b>Notes on the documentation</b> .....	<b>6</b>
<b>3</b>	<b>Product description</b> .....	<b>6</b>
3.1	Display and control elements.....	6
3.2	Displayed symbols.....	7
3.3	Serial number .....	7
3.4	CE marking .....	7
3.5	UKCA mark.....	8
3.6	Hot Water Association .....	8
3.7	Benchmark.....	8
<b>4</b>	<b>Operation</b> .....	<b>9</b>
4.1	Operating concept .....	9
4.2	Setting the language.....	10
4.3	Activating/deactivating the button lock .....	10
4.4	Heating mode .....	10
4.5	DHW mode .....	10
4.6	Using the <b>senseroom pure</b> <b>(VRT 50/2)</b> room temperature control.....	11
4.7	Calling up status codes.....	13
<b>5</b>	<b>Care and maintenance</b> .....	<b>13</b>
5.1	Caring for the product.....	13
5.2	Maintenance .....	13
5.3	Reading maintenance messages .....	13
5.4	Maintaining the pressure of the heating system.....	13
5.5	Checking the condensate discharge pipe and tundish.....	16
<b>6</b>	<b>Troubleshooting</b> .....	<b>16</b>
<b>7</b>	<b>Decommissioning</b> .....	<b>16</b>
7.1	Temporarily decommissioning the product.....	16
7.2	Permanently decommissioning the product.....	16
<b>8</b>	<b>Restarting</b> .....	<b>16</b>

<b>9</b>	<b>Recycling and disposal</b> .....	<b>17</b>
<b>10</b>	<b>Guarantee and customer service</b> .....	<b>17</b>
10.1	Guarantee.....	17
10.2	Customer service.....	17
	<b>Appendix</b> .....	<b>18</b>
<b>A</b>	<b>End user level</b> .....	<b>18</b>
A.1	Additional functions.....	19
<b>B</b>	<b>Status codes</b> .....	<b>19</b>
<b>C</b>	<b>Fault codes/limp home mode codes</b> .....	<b>20</b>
<b>D</b>	<b>Troubleshooting</b> .....	<b>20</b>
	<b>Index</b> .....	<b>22</b>

# 1 Safety

## 1.1 Intended use

The product is intended as a heat generator for sealed heating installations and for domestic hot water generation.

Intended use also includes the following:

- Using the product while observing the operating instructions included for the product and any other installation components
- Observing all inspection and maintenance intervals listed in the instructions

Any other use that is not specified in these instructions, or use beyond that specified in this document, shall be considered improper use.

Improper use of any kind is prohibited.

## 1.2 Qualification

- ▶ Employ only a qualified competent person to install, convert and set the product.

As the end user, you may carry out all of the work that is described in these instructions.

Exception: This product can be used by children aged from 8 years and above and persons with reduced physical, sensory or mental capabilities or lack of

experience and knowledge if they have been given supervision or instruction concerning use of the product in a safe way and understand the hazards involved. Children must not play with the product. Cleaning and user maintenance work must not be carried out by children unless they are supervised. Work that is described in other instructions must only be carried out by persons who meet the requirements described therein.

## 1.3 General safety information

The following sections convey important safety information. It is essential to read and observe this information in order to prevent risk of death, risk of injury, material damage or environmental damage.

### 1.3.1 Gas

If you smell gas:

- ▶ Avoid rooms that smell of gas.
- ▶ If possible, open doors and windows fully and ensure adequate ventilation.
- ▶ Do not use naked flames (e.g. lighters, matches).
- ▶ Do not smoke.
- ▶ Do not use any electrical switches, mains plugs, door-

bells, telephones or other communication systems in the building.

- ▶ Close the emergency control valve or the main isolator.
- ▶ If possible, close the gas stopcock on the product.
- ▶ Warn other occupants in the building by yelling or banging on doors or walls.
- ▶ Leave the building immediately and ensure that others do not enter the building.
- ▶ Alert the police and fire brigade as soon as you are outside the building.
- ▶ Use a telephone outside the building to inform the emergency service department of the gas supply company.

### **1.3.2 Risk of death from escaping gas**

What to do if you smell gas in the building:

- ▶ Avoid rooms that smell of gas.
- ▶ If possible, open doors and windows fully and ensure adequate ventilation.
- ▶ Do not use naked flames (e.g. lighters, matches).
- ▶ Do not smoke.
- ▶ Do not use any electrical switches, mains plugs, doorbells, telephones or other communication systems in the building.

- ▶ If it is safe to do so, close the emergency control valve or the main isolator.
- ▶ If possible, close the gas stopcock on the product.
- ▶ Warn other occupants in the building by yelling or banging on doors or walls.
- ▶ Leave the building immediately and ensure that others do not enter the building.
- ▶ Notify the gas supply company or the Emergency Service Provider +44 (0) 800 111999 by telephone once you are outside of the building.

### **1.3.3 Flue gas**

If you smell flue gas:

- ▶ Open all accessible doors and windows fully to provide ventilation.
- ▶ Switch off the product.
- ▶ Contact a competent person.

### **1.3.4 Subsequent product modifications**

- ▶ Never remove, bridge or block the safety devices.
- ▶ Do not tamper with any of the safety devices.
- ▶ Do not damage or remove any tamper-proof seals on components.
- ▶ Do not make any changes:
  - to the product itself

- to the gas, supply air, water and electricity supply lines
- to the entire flue system
- to the entire condensate discharge system
- to the expansion relief valve
- to the drain pipework
- to constructional conditions that may affect the operational reliability of the product
- ▶ Ensure that there is an evenly sufficient combustion air supply.

### **1.3.5 Material damage**

- ▶ Ensure that the combustion air supply is always free of fluorine, chlorine, sulphur, dust, etc.
- ▶ Ensure that no chemical substances are stored at the installation site.
- ▶ During a period of frost, ensure that the heating installation remains in operation and that all rooms are heated, even when you are away.
  - If a control is installed, switch the product on and off using the control to keep the frost protection devices active.
- ▶ If you cannot ensure the operation, have a competent person drain the heating installation.
- ▶ Only fill the heating installation with suitable heating wa-

ter and, in cases of doubt, ask a competent person about this.

### **1.3.6 Legionella**

- ▶ Have a competent person inform you about the measures that should be taken to protect against Legionella in your installation.
- ▶ Do not set any water temperatures below 60 °C without consulting the competent person first.

## 2 Notes on the documentation

- ▶ Always observe all operating instructions enclosed with the installation components.
- ▶ Store these instructions and all other applicable documents for further use.

These instructions apply for the following products only:

### Product article number

VU 10CS/1-5 (N-GB) ecoTEC plus 610	0010036009
VU 15CS/1-5 (N-GB) ecoTEC plus 615	0010036010
VU 20CS/1-5 (N-GB) ecoTEC plus 620	0010036011
VU 25CS/1-5 (N-GB) ecoTEC plus 625	0010036012
VU 30CS/1-5 (N-GB) ecoTEC plus 630	0010036013
VU 35CS/1-5 (N-GB) ecoTEC plus 635	0010036014
VUW 20/26CS/1-5 (N-GB) ecoTEC plus 826	0010036015
VUW 25/32CS/1-5 (N-GB) ecoTEC plus 832	0010036016
VUW 30/36CS/1-5 (N-GB) ecoTEC plus 836	0010036017
VUW 30/40CS/1-5 (N-GB) ecoTEC plus 840	0010036018
VUI 30/40CS/1-5 (N-GB) ecoTEC plus 940	0010036114

### Gas Council Numbers

VU 10CS/1-5 (N-GB) ecoTEC plus 610	41-694-45
VU 15CS/1-5 (N-GB) ecoTEC plus 615	41-694-46
VU 20CS/1-5 (N-GB) ecoTEC plus 620	41-694-47
VU 25CS/1-5 (N-GB) ecoTEC plus 625	41-694-48
VU 30CS/1-5 (N-GB) ecoTEC plus 630	41-694-49
VU 35CS/1-5 (N-GB) ecoTEC plus 635	41-694-50

VUW 20/26CS/1-5 (N-GB) ecoTEC plus 826	47-044-92
VUW 25/32CS/1-5 (N-GB) ecoTEC plus 832	47-044-93
VUW 30/36CS/1-5 (N-GB) ecoTEC plus 836	47-044-94
VUW 30/40CS/1-5 (N-GB) ecoTEC plus 840	47-044-95
VUI 30/40CS/1-5 (N-GB) ecoTEC plus 940	47-044-96

## 3 Product description



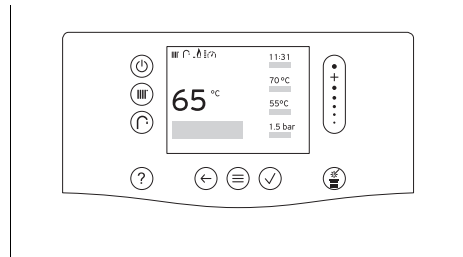







### 3.1 Display and control elements







Control element	Function
	<ul style="list-style-type: none"> <li>– Activate/deactivate standby mode: Press for less than three seconds</li> <li>– Reset button: Press and hold for more than three seconds to restart</li> </ul>
	Setting the desired flow temperature from the boiler
	Setting the desired domestic hot water temperature from the boiler
	<ul style="list-style-type: none"> <li>– Calling up help</li> <li>– Calling up the time programme assistant (control module)</li> </ul>
	<ul style="list-style-type: none"> <li>– Go one level back</li> <li>– Cancelling input</li> </ul>
	<ul style="list-style-type: none"> <li>– Calling up the menu</li> <li>– Back to the main menu</li> <li>– Calling up the basic display</li> </ul>
	<ul style="list-style-type: none"> <li>– Confirming a selection/change</li> <li>– Saving the set value</li> </ul>
	Call up chimney sweep mode (carry out combustion analysis). For competent persons only.

Control element	Function
	<ul style="list-style-type: none"> <li>– Navigating through the menu structure</li> <li>– Reducing or increasing the set value</li> <li>– Navigating to individual numbers and letters</li> </ul>

## 3.2 Displayed symbols

Symbol	Meaning
	Current burner modulation rate (display in five levels).
	Current system pressure (display in five levels): <ul style="list-style-type: none"> <li>– Permanently on: Filling pressure in the permitted range</li> <li>– Flashing: Filling pressure outside the permitted range</li> </ul>
	Heating mode activated: <ul style="list-style-type: none"> <li>– Permanently on: Burner off, no heat demand</li> <li>– Flashing: Burner on, heat demand present</li> </ul>
	Heating mode is switched off
	Domestic hot water generation activated: <ul style="list-style-type: none"> <li>– Permanently on: Burner off, no heat demand</li> <li>– Flashing: Burner on, heat demand present</li> </ul>
	<b>Product with integrated domestic hot water generation or product with connected domestic hot water cylinder</b> Comfort mode activated: <ul style="list-style-type: none"> <li>– Permanently on: Comfort mode is activated</li> <li>– Flashing: Burner on, comfort mode on</li> </ul>
	Installer level active
	Display locked
	Connected to the system control
	Connection to the Vaillant server established

Symbol	Meaning
	Product is busy with a task.
	Setting the time: <ul style="list-style-type: none"> <li>– Permanently on: Time is set</li> <li>– Flashing: The time must be reset</li> </ul>
	Warning
F.XXX	Fault in the product: Appears instead of the basic display, may be an explanatory plain text display.
N.XXX	Limp home mode: Appears instead of the basic display, may be an explanatory plain text display.
	Maintenance required: You can find more information in code I.XXX.
I.XXX	Maintenance required: Appears instead of the basic display, may be an explanatory plain text display.

## 3.3 Serial number

The serial numbers are located on the underside of the front panel and on the data plate.

The 3rd to 6th digits provide the production date (year/week), the 7th to 16th digit provide the article number for the product.

## 3.4 CE marking



The CE marking shows that the products comply with the basic requirements of the applicable directives as stated on the declaration of conformity.

The declaration of conformity can be viewed at the manufacturer's site.

### 3.5 UKCA mark



The UKCA marking shows that the products comply with the basic requirements of the applicable directives as stated on the declaration of conformity.

The declaration of conformity can be viewed at the manufacturer's site.

### 3.6 Hot Water Association

Vaillant is a full member of the Hot Water Association and promotes the scheme in association with its cylinder range. Details are available on the web site [www.vaillant.co.uk](http://www.vaillant.co.uk)



CHARTER MEMBER

The HWA Charter's Code of Practice requires that all members adhere to the following:

- To supply fit for purpose products clearly and honestly described
- To supply products that meet, or exceed appropriate standards and building and water regulations
- To provide pre and post sales technical support
- To provide clear and concise warranty details to customers

### 3.7 Benchmark



Vaillant is a licensed member of the Benchmark Scheme which aims to improve the standards of installation and commissioning of domestic heating and hot water systems in the UK and to encourage regular servicing to optimise safety, efficiency and performance.

Benchmark is managed and promoted by the Heating and Hotwater Industry Council. For more information visit [www.benchmark.org.uk](http://www.benchmark.org.uk).

- ▶ Please ensure that the installer has fully completed the Benchmark Checklist on the inside back pages of the installation instructions supplied with the product and that you have signed it to say that you have received a full and clear explanation of its operation. The installer is legally required to complete a commissioning checklist as a means of complying with the appropriate Building Regulations (England and Wales).

All installations must be notified to Local Area Building Control either directly or through a Competent Persons Scheme. A Building Regulations Compliance Certificate will then be issued to the customer who should, on receipt, write the Notification Number on the Benchmark Checklist. This product should be serviced regularly to optimise its safety, efficiency and performance. The service engineer should complete the relevant Service Record on the Benchmark Checklist after each service.

The Benchmark Checklist will be required in the event of any warranty.



## 4 Operation

### 4.1 Operating concept

Control elements that are lit up in colour can be selected.

Adjustable values and list entries can be changed using the scrollbar. Briefly tap on the top and bottom end of the scrollbar in order to implement changes.

You must confirm a change to a value. Only then is the new setting saved. You have to press flashing control elements again to confirm.

Control elements that are lit up in white are active.

The menu and the control elements are dimmed after 60 seconds in order to save energy. The status display is shown after another 60 seconds.

You can find additional assistance for the control elements under **MENU** → **INFORMATION** → **Control elements**.

#### 4.1.1 Basic display

If the status display is shown, press  to call up the basic display.

In the basic display, you can set the desired domestic hot water temperature and flow temperature/desired temperature (desired temperature only available for products with a control module).

The flow temperature is the temperature at which the heating water leaves the heat generator (e.g. 65 °C).

The desired temperature is the temperature that is actually desired for the living room (e.g. 21 °C).

Press  to set the temperature for domestic hot water mode.

Press  to set the temperature for heating mode.

Further settings for heating mode and domestic hot water mode are described in the relevant sections.

If the basic display is shown, press  to call up the menu.

The functions that are available in the menu depend on whether a system control is connected to the product. If you have connected a system control, the settings for heating mode must be available in the system control. (→ System control operating instructions)

You can find additional assistance for the navigation under **MAIN MENU** → **INFORMATION** → **Menu introduction**.

If there is an error message present, the basic displays switches to the error message.



#### Note

If a code request appears after you press , your competent person has locked access to the control panel in order to prevent settings from being accidentally changed. Contact your competent person.

#### 4.1.2 Operating levels







If the basic display is shown, call up the menu in order to display the end user level.

In the end user level, you can change and individually adapt the settings for the product. The table in the appendix lists the menu items and setting options that can be selected. (→ Appendix A)



A timer is built into the boiler for the heating circuit but is only activated and visible with the use of a Vaillant sensorROOM pure (VRT 50/2) control.

The installer level must only be operated by persons with expertise and is therefore protected by a code.

## 4.2 Setting the language

1. Press  twice.
2. Navigate to the bottom menu item ( **XXX**) and confirm by pressing .
3. Select the third menu item and confirm by pressing .
4. Select the first menu item and confirm by pressing .
5. Select the required language and confirm by pressing .

## 4.3 Activating/deactivating the button lock

1. Call up **MENU** → **SETTINGS** → **Button lock**.
2. Confirm by pressing .  
– The button lock is activated.
3. To deactivate the button lock, press and hold  for four seconds.

## 4.4 Heating mode

In heating mode, the rooms are heated up in accordance with your settings.

### 4.4.1 Setting the flow temperature

**Validity:** Product without connected sensoROOM pure (VRT 50/2) AND Product without system control

- ▶ From the basic display, press .
  - ◁ The flow temperature that has already been set is shown in the display.
- ▶ Set the desired flow temperature.

**Validity:** Product with connected sensoROOM pure (VRT 50/2) OR Product with system control

- ▶ Set the desired temperature on the control or room temperature control; see operating and installation instructions for the control or room temperature control.

### 4.4.2 Permanently switching off heating mode (summer mode)

**Validity:** Product without connected sensoROOM pure (VRT 50/2)

- ▶ From the basic display, press  for at least three seconds.
  - ◁ Heating mode is switched off.
  - ◁ The symbol for heating mode is shown as deactivated in the display.

**Validity:** Product with connected sensoROOM pure (VRT 50/2)

- ▶ Set the lowest target room temperature on the room temperature control; see operating and installation instructions for the room temperature control.
  - ◁ Heating mode is switched off.



#### Note

If the **sensioROOM pure (VRT 50/2)** room temperature control is connected, you cannot set the desired temperature on the product's control panel.

## 4.5 DHW mode

**Validity:** Product with integrated hot water generation OR Product with connected domestic hot water cylinder

In domestic hot water mode, the potable water is heated to the required domestic hot water temperature.

### 4.5.1 Setting the domestic hot water temperature

1. From the basic display, press .
2. Set the required domestic hot water temperature.

## 4.5.2 Switching off the domestic hot water mode

**Validity:** Product with connected domestic hot water cylinder OR Product with integrated hot water generation and shift-load cylinder

- ▶ Starting from the basic display, press  for at least five seconds.
  - ◁ The domestic hot water mode is switched off.

## 4.5.3 Switching comfort mode on/off



### Note

Comfort mode keeps the domestic hot water generation ready and supplies hot water at the desired temperature without you having to wait for the heat-up time.

**Validity:** Product without connected sensoROOM pure (VRT 50/2)

- ▶ Call up **MAIN MENU** → **CONTROL** → **Comfort mode**.
- ▶ Activate **On** or **Off**.

**Validity:** Product with connected sensoROOM pure (VRT 50/2)

- ▶ Switch the warm start (comfort function) on and off at the room temperature control, see operating and installation instructions for the room temperature control.



### Note

Prerequisite: The comfort mode is activated on the product.

## 4.5.4 Activating the shift-load cylinder

**Validity:** Product with integrated hot water generation and shift-load cylinder

The comfort mode for activating the **actoSTOR** shift-load cylinder is already switched on at the factory.

- ▶ Set the domestic hot water temperature.

**Condition:** Cylinder charging switched on

- Hot water temperature: 50 to 65 °C



## Danger!

### Risk of scalding!

The products are equipped with an automatic anti-legionella function: If the temperature in the shift-load cylinder falls below 50 °C for 24 hours, the cylinder is heated up to 70 °C once.

- ▶ Please note when drawing water that it can be very hot.

- ▶ If you want to switch off the Anti-legionella function, ask a competent person about this.
- ▶ If you want to switch off cylinder charging, deactivate comfort mode. (→ Section 4.5.3)

**Condition:** Cylinder charging switched off

- Hot water temperature: 35 to 65 °C
- ◁ The cylinder is not maintained at a specific temperature. If you draw off the water, the product switches on and, in this case, only operates as an instantaneous water heater.

## 4.6 Using the sensoROOM pure (VRT 50/2) room temperature control

**Validity:** Product with connected sensoROOM pure (VRT 50/2)

If a **sensuROOM pure (VRT 50/2)** room temperature control is connected, this additional function is automatically available in the heat generator and it offers the option to control the room control timings. It represents the digital further development of the familiar control process via **timeSWITCH**.

The temperature is controlled directly at the room temperature control. On the heat generator's control panel, the time control can be switched on/off and the time period settings can be implemented.

### Switching the time control on/off

You have two options:

- Continuous heating (**Heating timer = Off**)
- Time-dependent heating (**Heating timer = On**)

Activate the time control on the heat generator. (→ Section 4.4.2)

### Setting time periods

Prerequisite: **Heating timer = On**

You have two options:

- Direct configuration of daily schedules in the weekly planner
- Configuration of the time periods with the time programme assistant

Set the time periods on the heat generator's control panel. (→ Section 4.6.2)

### Switching off heating mode

The heating mode can only be switched off by decreasing the target room temperature to the minimum value of 15 °C. (→ Section 4.4.2)



#### Note

The level of the minimum target room temperature can be decreased even further (5 °C), see the operating and installation instructions for the room temperature control.

## 4.6.1 Switching the time control on/off

**Validity:** Product with connected sensoROOM pure (VRT 50/2)

1. Call up **MAIN MENU** → **CONTROL** → **Heating timer**.
2. Activate **On** or **Off**.

## 4.6.2 Setting the time period using the weekly planner

**Validity:** Product with connected sensoROOM pure (VRT 50/2)

Set the time periods on the control panel on the product instead of on the room control.

Call up **MAIN MENU** → **CONTROL** → **Heating timer** → **Weekly planner**.

You can use a separate weekly planner for heating mode for:

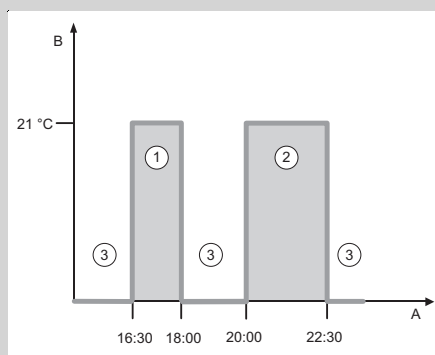

A	Time	2	Time period 2
B	Temperature	3	Outside of the time periods
1	Time period 1		

*Time programme example for explanation; does not appear on the display in this form*

The temperature is controlled directly at the room control. For active time periods, only one target room temperature value can be selected manually on the room control.

Time periods are already set for each day of the week at the factory.

You can divide a day up into several time periods (1) and (2). Each time period can comprise an individual start time and end time. The time periods must not overlap.

Example:

16:30 to 18:00; 21 °C  
20:00 to 22:30; 21 °C

The living rooms are regulated to the desired temperature within the time periods. During the times outside of the time periods **(3)**, the living rooms are not heated.

For heating mode, you can save up to 12 time periods for each day of the week. The desired temperature set on the room control applies within these time periods.

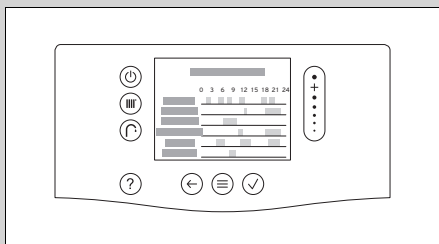

The active list entry is displayed lit up in white.

You can use **Copy settings to...** to transfer start and end time periods that have already been programmed to another day of the week.

You can find simplified programming of the time periods for heating mode under **MAIN MENU → CONTROL → Time programme assistant**.

#### 4.6.3 Setting time periods using the time programme assistant

**Validity:** Product with connected sensoROOM pure (VRT 50/2)

You can use a time programme assistant for heating mode.

Call up **MAIN MENU → CONTROL → Time programme assistant**.

The time programme assistant guides you through the planning. There is a block for **Mon–Fri** and **Sat–Sun**.

The time programme assistant overwrites the weekly planner that has been created for heating mode.

## 4.7 Calling up status codes

- ▶ Call up **MENU → INFORMATION → Status code**.

Status codes (→ Appendix B)

- ◁ The current operating mode (status code) is shown on the display.

## 5 Care and maintenance

### 5.1 Caring for the product

- ▶ Clean the casing with a damp cloth and a little solvent-free soap.
- ▶ Do not use sprays, scouring agents, detergents, solvents or cleaning agents that contain chlorine.

### 5.2 Maintenance

An annual inspection of the product carried out by a competent person is a prerequisite for ensuring that the product is permanently ready and safe for operation, reliable, and has a long working life.

### 5.3 Reading maintenance messages

If the  symbol is shown in the display, the product requires maintenance work.

The product is not in fault mode but continues to operate.

- ▶ Consult a competent person about this.
- ▶ If the water pressure is flashing at the same time, simply add more heating water.

### 5.4 Maintaining the pressure of the heating system

#### 5.4.1 Checking the filling pressure of the heating installation

You have multiple options for reading the filling pressure of the heating installation.

- On the basic display, as a value on the bottom right on the display.
- On the basic display, as a symbol on the upper edge (five stage bars).

- On the **INFORMATION** menu, as a value compared to the minimum and maximum filling pressure.
- ▶ Call up **MAIN MENU** → **INFORMATION** → **Water pressure**:
  - ◀ The value for the current filling pressure appears on the display.
- ▶ Check the filling pressure in the display.
- ▶ We recommend a filling pressure of at least 1 bar (0.1 MPa). If the filling pressure is lower than 0.8 bar (0.08 MPa), top up the heating water and, in doing so, increase the excess pressure in the heating installation.

### 5.4.2 Topping up and purging the heating installation



#### Caution.

**Risk of material damage due to heating water that is extremely calciferous or corrosive or contaminated by chemicals.**

Unsuitable tap water damages the seals and diaphragms, blocks components in the product and heating installation through which the water flows and causes noise.

- ▶ Only fill the heating installation with suitable heating water.

The heating installation is a sealed system. Sufficient filling and purging is the basis for a well-functioning system.

Have your competent person explain the filling and purging process to you. Each heating installation is individual.

Proceed as follows: Fill up, purge and check the pressure. If required, top up again.

For products with an integrated domestic hot water generation and products with a shift-load cylinder, an appropriate filling

device is available. Use the filling device to fill the heating installation and create the required excess pressure.

For products with a connected domestic hot water cylinder, a filling device must be set up by the competent person and its use explained.

Recommendation for the excess pressure: At least 1.0 bar (0.1 MPa), maximum 2.5 bar (0.25 MPa) with correct active pressure compensation, good standard value 1.5 bar (0.15 MPa).

- ▶ Check the height to which the heating installation extends (highest radiator).
- ▶ For each metre of height, also add 0.1 bar (0.01 MPa) to the minimum excess pressure.
  - Example: Minimum excess pressure 1.0 bar (0.1 MPa) -> Height of the heating installation 8 m (cellar to roof) = 0.8 bar (0.08 MPa) -> Target filling pressure = 1.8 bar (0.18 MPa)
- ▶ Read the pressure level that appears on the display or on an external manometer, if available. (→ Section 5.4.1)



#### Note

If the pressure that you select is too high and it reaches the limit level, the expansion relief valve opens. If there is no longer sufficient pressure compensation through the diaphragm expansion vessel, this may already be the case at the maximum pressure of 2.5 bar (0.25 MPa).

If the pressure is too low, under certain circumstances, this may lead to fault message **F.22** and the product temporarily shuts down. Fault message **F.22** goes out and the product automatically works again once a certain pressure level is reached again.

**Validity:** Product with integrated hot water generation  
OR Product with integrated hot water generation and  
shift-load cylinder

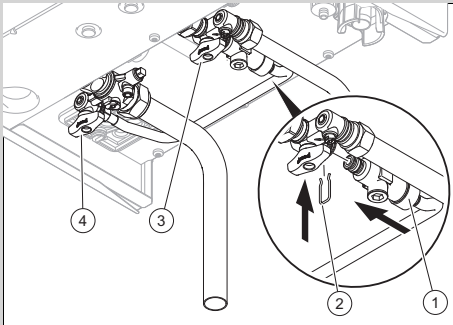

- ▶ Open all radiator valves (thermostatic valves) of the heating installation.
- ▶ Fit the double non-return valve (1) of the filling line to the cold-water isolation valve and secure the valve with the spring clip (2).
- ▶ To fill, first open the isolation valve (3).
- ▶ Open the isolation valve (4) so that the water flows into the heating system. Fill the heating installation.
- ▶ Monitor the rising filling pressure in the heating installation.
- ▶ Fill with water until the required filling pressure is reached.
- ▶ After filling, close isolation valve (4) first and then isolation valve (3). Disconnect the filling device by removing the double non-return valve from the cold-water isolation valve.



#### Note

Both isolation valves must be closed while the heating installation is operating and the filling line must be removed from the double non-return valve again.

**Validity:** Product with connected domestic hot water cylinder

- ▶ Carry out the filling and purging process as explained to you by the competent person.
- ▶ Open the heating water supply.

- ▶ Open all radiator valves (thermostatic valves) of the heating installation.
- ▶ If necessary, check that both service valves on the product are open.
- ▶ Slowly open the filling/draining cock so that the water flows into the heating installation.
- ▶ Monitor the rising filling pressure in the heating installation.
- ▶ Fill with water until the required filling pressure is reached.
- ▶ Close the filling device as explained to you by the competent person.

The prerequisite for the purging is that the heating installation is under sufficient pressure. The heating installation can now be purged again. Our recommendation: The heating installation should be purged once a year before the heating season. The purging may be varied. If required, consult your competent person for more information.

- ▶ Start the purging at the radiators that are closest to the heat generator, and continue with the radiators that are positioned further away. Purge until the water flows out at the purging valve without any bubbles.
- ▶ Purge all of the radiators until the entire heating installation is filled with water.
- ▶ Close all purging valves.



#### Note

If you notice that the purging output decreases, check the pressure in the interim and, if required, re-establish the target pressure level by filling the installation.

Following purging, the pressure level has fallen.

- ▶ Lastly, check the filling pressure once again and, if required, adjust this again.

## 5.5 Checking the condensate discharge pipe and tundish

The condensate discharge pipe and tundish must never be blocked and condensate should be able to flow freely.

- ▶ Regularly check the condensate discharge pipe and tundish for faults and, particularly, for blockages.

You must not be able to see or feel any obstructions in the condensate discharge pipe and tundish.

- ▶ If you notice a fault, have it eliminated by a competent person.

## 6 Troubleshooting



### **Danger!** Risk of death caused by improper repair work

- ▶ If the power supply cable is damaged, never replace this yourself.
- ▶ Contact the manufacturer, customer service or a similar qualified person.

- ▶ If fault codes (**F.XXX**), LHM codes (**N.XXX**) are shown in the display or faults occur, proceed in accordance with the tables in the appendix. Fault codes/limp home mode codes (→ Appendix C) Troubleshooting (→ Appendix D)
- ▶ If you are unable to eliminate the fault or malfunction using the specified measures in the tables, contact a competent person.
- ▶ If **N.XXX** limp home mode codes are shown on the display, the system can still be operated safely; however, please contact a competent person to have the fault eliminated.

## 7 Decommissioning

### 7.1 Temporarily decommissioning the product

**Condition:** Risk of frost

- ▶ Press .
  - ◁ The display goes out. The standby button continues to light up.
  - ◁ However, the frost protection for the heating installation is active.

**Condition:** No risk of frost

- ▶ Switch off the product at the switched fused spur box.
  - ◁ The display goes out. The product is not working.
  - ◁ The frost protection function is deactivated.
- ▶ Close the gas stopcock on the product.

**Validity:** Product with integrated hot water generation  
OR Product with connected domestic hot water cylinder

- ▶ Close the cold-water isolation valve.

### 7.2 Permanently decommissioning the product

- ▶ Have a competent person permanently decommission the product.

## 8 Restarting

1. If the product was switched off at the switched fused spur box, switch it back on there.
  - ◁ The display lights up.
2. If the gas stopcock on the product was closed, open the gas stopcock.
  - ◁ The product starts up.

**Validity:** Product with integrated hot water generation  
OR Product with connected domestic hot water cylinder

- ▶ Open the cold-water isolation valve.



## 9 Recycling and disposal

### Disposing of the packaging

- ▶ The competent person who installed your product is responsible for the disposal of the packaging.

### Disposing of the product



■ If the product is labelled with this mark:

- ▶ In this case, do not dispose of the product with the household waste.
- ▶ Instead, hand in the product to a collection centre for waste electrical or electronic equipment.

### Disposing of batteries



■ If the product contains batteries that are labelled with this mark:

- ▶ In this case, dispose of the batteries at a collection point for batteries.
  - ◁ **Prerequisite:** The batteries can be removed from the product without causing any destruction. Otherwise, the batteries are disposed of together with the product.
- ▶ In accordance with the legal regulations, used batteries must be returned since batteries may contain substances that are harmful to health and the environment.

### Deleting personal data

Personal data may be misused by unauthorised third parties.

If the product contains personal data:

- ▶ Ensure that there is no personal data on or in the product (e.g. online login details or similar) before you dispose of the product.

## 10 Guarantee and customer service

### 10.1 Guarantee

- Two year guarantee for ecoTEC plus appliances
- Extended guarantees may apply to your product and may be subject to certain installation conditions, please consult your installer and see Vaillant website for more information

Vaillant provides this appliance with a parts and labour guarantee against defects that may occur within twenty-four months of the installation date. For the 2nd year of the guarantee to be valid an annual service must be carried out by a competent person approved at the time by the Health and Safety Executive one year after installation. The cost of this annual service is not included in the guarantee.

- Registering with us

Registration is simple. Just complete the Guarantee Registration Card and return to Vaillant within 30 days of installation. Your details will then be automatically registered within the Vaillant scheme.

- Immediate help

If your Vaillant boiler develops a fault your first action should be to contact your installer, as his professional assessment is needed under the terms of our Guarantee. If you are unable to contact your installer, phone Vaillant Service Solutions:

Telephone: 0330 100 3143

### 10.2 Customer service

For contact details for our customer service department, you can write to the address that is provided on the back page, or you can visit [www.vaillant.co.uk](http://www.vaillant.co.uk).

# Appendix

## A End user level

When the status display is displayed, press  twice to call up the menu.

CONTROL menu item	
<b>Comfort mode:</b>	<b>Product with integrated domestic hot water generation or product with connected domestic hot water cylinder</b> On: Keeps the domestic hot water generation ready.
INFORMATION menu item	
<b>Water pressure:</b>	Displays the current water pressure.
<b>Energy data</b>	→ <b>Gas consumption</b>
	→ <b>Heating</b>
	→ <b>DHW</b>
	→ <b>Power consumption</b>
	→ <b>Heating</b>
	→ <b>DHW</b>
	<p>The product, the system control and the app show approximate values for energy consumption, energy yields and efficiencies, which are extrapolated based on calculation algorithms. The values that are displayed in the app may differ from the other display options due to staggered transfer intervals. The determined values depend on:</p> <ul style="list-style-type: none"> <li>– Installation and system of the heating installation</li> <li>– User behaviour</li> <li>– Seasonal weather effects</li> <li>– Various tolerances of unit-internal components</li> </ul> <p>The values can be read in the following time forms:</p> <ul style="list-style-type: none"> <li>– Today</li> <li>– Yesterday</li> <li>– Last month</li> <li>– Last year</li> <li>– Total</li> </ul> <p>The recording of the values only includes the product in the factory-delivered condition. Supplementary accessories, even if they are installed on the product, as well as any other components in the heating system and other external consumers, are not part of the data recording.</p> <p>Deviations between the determined values and the actual values may be significant. The determined values are therefore not suitable for creating or comparing energy billing, for example.</p> <p><b>Note</b></p> <p>When replacing the PCB, the values recorded up to that point are completely reset in the product and system control.</p>
<b>Status code</b>	Displays the current status code.
<b>Control elements</b>	Step-by-step explanation of the individual control elements.
<b>Menu introduction</b>	Explanation of the menu structure.
<b>Installer contact info</b>	→ <b>Phone no.</b> → <b>Company</b>

INFORMATION menu item	
Software version	Displays the software versions.
SETTINGS menu item	
Chimney sweep mode	→ Adjustable heat load
	→ Max. DHW output
	→ Min. heat input
Installer level	
Language, clock, display settings	→ Language:
	→ Date:
	→ Time:
	→ Display brightness:
	→ Daylight saving time:

## A.1 Additional functions

**Validity:** Product with connected sensoROOM pure (VRT 50/2)

CONTROL menu item	
Heating timer	On: Heating mode is permanently switched on.
	→ Weekly planner
Time programme assistant	Programming of the desired temperature for the weekly blocks Monday-Friday and Saturday-Sunday.

## B Status codes



### Note

Since the code table is used for various products, some codes may not be visible for the product in question.

The code table only shows an extract of the entire code.

Code	Meaning
S.000	There is no demand for heating mode.
S.002	Heating mode is active and the heating pump is in prerun mode.
S.003	Heating mode is active and the unit ignites.
S.004	Heating mode is active and the burner is operating.
S.006	Heating mode is active and the fan is in overrun mode.
S.007	Heating mode is active and the heating pump is in overrun mode.
S.008	Heating mode is active and the unit is in burner anti-cycling time.
S.012	The domestic hot water draw-off is active and the heating pump is in prerun mode.
S.013	The domestic hot water draw-off is active and the unit ignites.
S.014	The domestic hot water draw-off is active and the burner is operating.
S.016	The domestic hot water draw-off is active and the fan is in overrun mode.
S.017	The domestic hot water draw-off is active and the heating pump is in overrun mode.

Code	Meaning
S.020	There is no demand for the domestic hot water cylinder charging.
S.022	The domestic hot water cylinder charging is active and the pump is in prerun mode.
S.023	The domestic hot water cylinder charging is active and the unit ignites.
S.024	The domestic hot water cylinder charging is active and the burner is operating.
S.026	The domestic hot water cylinder charging is active and the fan is in overrun mode.
S.027	The domestic hot water cylinder charging is active and the heating pump is in overrun mode.
S.028	The domestic hot water cylinder charging is active and the unit is in burner anti-cycling time.
S.031	Heating mode has been deactivated and there is no domestic hot water demand.
S.034	The frost protection function is active.

## C Fault codes/limp home mode codes



### Note

The code table only shows an extract of the entire code. If fault codes or limp home mode codes other than those listed are displayed, action by a competent person is required.

Code/meaning	Possible cause	Measure
<b>F.022</b> No/insufficient water in the product or the water pressure is too low.	Water deficiency in the heating installation	<ol style="list-style-type: none"> <li>1. Check the filling pressure of the heating installation. (→ Section 5.4.1)</li> <li>2. Top up with heating water. (→ Section 5.4.2)</li> </ol>
<b>F.028</b> The flame signal was not detected during the ignition phase.	After five unsuccessful ignition attempts, the product has switched to fault mode.	<ol style="list-style-type: none"> <li>1. Check whether the gas stopcock is open.</li> <li>2. Press the reset button for longer than three seconds. <ul style="list-style-type: none"> <li>– Maximum number of repetitions: 3</li> </ul> </li> <li>3. If you are unable to eliminate the ignition fault, contact a competent person.</li> </ol>

## D Troubleshooting

Symptom	Possible cause	Measure
Product does not start up (no hot water, heating remains cold)	The gas isolator cock installed on-site and/or the gas isolator cock on the product is closed.	► Open both gas isolator cocks.
	The power supply in the building is disconnected.	► Check the fuse in the building. The product automatically switches back on when the power supply is restored.

Symptom	Possible cause	Measure
Product does not start up (no hot water, heating remains cold)	The cold water stop valve is closed.	▶ Open the cold water stop valve.
	The product is switched off.	▶ Restart the product. (→ Section 8)
	The room temperature/domestic hot water temperature has been set too low and/or heating mode/domestic hot water mode has been switched off.	<ol style="list-style-type: none"> <li>1. Set the flow temperature. (→ Section 4.4.1)</li> <li>2. Set the domestic hot water temperature. (→ Section 4.5.1)</li> </ol>
	There is air in the heating installation.	<ol style="list-style-type: none"> <li>1. Purge the heating installation (→ "Topping up the heating installation" section).</li> <li>2. If you are unable to purge the heating installation yourself, contact a competent person.</li> </ol>
Heating will not start (hot water generation OK)	The external control is not set correctly.	▶ Set the external control correctly (→ Control operating instructions).

# Index

## B

Battery ..... 17

## C

CE marking ..... 7

Combustion air ..... 5

Comfort mode ..... 11

Condensate ..... 16

Condensate discharge pipe ..... 16

Control elements ..... 6

Cylinder charging

Switching off ..... 11

## D

Decommissioning, permanently ..... 16

Display ..... 6

Disposal ..... 17

Documents ..... 6

Domestic hot water temperature ..... 10

## F

Filling ..... 14

Filling pressure, increasing ..... 14

Frost ..... 5

## H

Heating mode

Switching off ..... 10

## I

If you smell gas ..... 4

Intended use ..... 3

## L

Language

Setting ..... 10

Legionella ..... 11

## M

Maintenance ..... 13

Maintenance message ..... 13

## O

Operating level ..... 9

## P

Preventing material damage ..... 5

Purging ..... 14

## R

Recycling ..... 17

## S

Setting the desired temperature ..... 10

Setting the flow temperature ..... 10

Shift-load cylinder

Activating ..... 11

Status codes

Calling up ..... 13

Summer mode ..... 10

## T

Timer ..... 12

Troubleshooting ..... 16

Tundish ..... 16

## U

UKCA mark ..... 8

## W

Warm start ..... 11



**Supplier****Vaillant Group UK Ltd.**

Nottingham Road ■ Belper ■ Derbyshire ■ DE56 1JT ■ Great Britain

Telephone 0330 100 3143

info@vaillant.co.uk ■ www.vaillant.co.uk



0020308119\_03

**Publisher/manufacture****Vaillant GmbH**

Berghauser Str. 40 ■ D-42859 Remscheid ■ Deutschland, Germany

Tel. +49 2191 18 0 ■ Fax +49 2191 18 2810

info@vaillant.de ■ www.vaillant.de

© These instructions, or parts thereof, are protected by copyright and may be reproduced or distributed only with the manufacturer's written consent.

Subject to technical modifications.