

For the operator

Operating instructions



VRT 350

VRT 350

GB, IE

Legal information

Document type:	Operating instructions
Product:	VRT 350
Target group:	Operator
Language:	EN
Document number_version:	0020135485_01
Created on:	24.05.2012

Publisher/manufacturer

Vaillant GmbH

Berghauser Str. 40 ■ D-42859 Remscheid
Telefon +49 21 91 18-0 ■ Telefax +49 21 91 18-28 10
info@vaillant.de ■ www.vaillant.de

© Vaillant GmbH 2012

These instructions, or extracts thereof, may only be printed with the written consent of Vaillant GmbH.
All designations of products in these instructions are brand names/trade marks of the companies in question.
We reserve the right to make technical changes.

Contents	5	Operating and display functions.....	21
	5.1	Information.....	21
1 Notes on the documentation	4	5.2 Settings.....	22
1.1 Symbols and signs used.....	4	5.3 Operating modes.....	28
1.2 Observing other applicable documents	4	5.4 Special operating modes	30
1.3 Document storage	4	5.5 Messages	31
1.4 Applicability of the instructions	4	6 Service and troubleshooting	32
2 Safety	5	6.1 Cleaning the controller.....	32
2.1 Action-related warnings	5	6.2 Detecting and rectifying faults	32
2.2 Required personnel qualifications	5	7 Decommissioning.....	33
2.3 General safety information	5	7.1 Replacing the controller.....	33
2.4 CE label	6	7.2 Recycling and disposal.....	33
2.5 Intended use.....	6	8 Warranty and customer service	33
3 Overview of the equipment.....	8	8.1 Warranty	33
3.1 Unit design.....	8	8.2 Customer service.....	33
3.2 Identification plate.....	8	9 Technical data.....	34
3.3 Serial number	8	9.1 Controller	34
3.4 Control function.....	8		
3.5 Frost protection function	9		
4 Operating.....	9		
4.1 Operating structure	9		
4.2 Operating concept	12		
4.3 Overview of setting and read-out options	16		





1 Notes on the documentation

1 Notes on the documentation

1.1 Symbols and signs used

Symbols

The following symbols may appear:

	Warning symbol (→ Page 5)
	Information symbol
	Symbol for a required action.
	Symbol for the result of an action.

1.2 Observing other applicable documents

- ▶ You must observe all instructions for use that are enclosed with other components of your system.

1.3 Document storage

- ▶ Store the enclosed operating instructions and all other applicable documents in such a way that they are available whenever required and for any subsequent operators of the system.

1.4 Applicability of the instructions

These instructions apply for the following only:

Article number

Great Britain	0020124475
---------------	------------



2 Safety

2.1 Action-related warnings

Classification of action-related warnings

The action-related warnings are classified in accordance with the severity of the possible danger using the following warning signs and signal words:

Warning symbols and signal words



Danger!

Imminent danger to life or risk of severe personal injury



Danger!

Risk of death from electric shock



Warning.

Risk of minor personal injury



Caution.

Risk of material or environmental damage

2.2 Required personnel qualifications

These instructions are aimed at those who are able to operate a heating installation but do not have any special technical knowledge or experience.

2.2.1 Instructed operator (Operator)

Definition:

Instructed operator	<p>The operator is charged with operation and maintenance of the unit. He/she must ensure compliance with maintenance intervals. He/she does not require any special technical knowledge or experience.</p> <p>The operator must have been instructed in the following topics by the authorised skilled tradesman.</p> <ul style="list-style-type: none"> – General safety information – Function and location of safety devices on the system – Operation of the unit – Energy-saving operation – Maintenance operations
---------------------	--

2.3 General safety information

2.3.1 Installation only by a skilled tradesman

Installation of the unit can be only carried out by an approved, skilled tradesman. This skilled tradesman is also responsible for proper installation and start-up.

2.3.2 Risk of scalding from hot water

There is a risk of scalding at the hot water draw-off points if the set target temperature is greater than 60 °C. Young



2 Safety

children and elderly persons are particularly at risk, even at lower temperatures.

- ▶ Select a moderate target temperature.

2.3.3 Danger caused by a malfunction

- ▶ Ensure that air can circulate freely around the controller, and that the controller is not covered by furniture, curtains or other objects.
- ▶ Ensure that all radiator valves in the room where the controller is fitted are fully open.
- ▶ Only operate the heating installation when it is in a technically perfect condition.
- ▶ Ensure that any faults and damage that may negatively affect safety are rectified immediately.

2.3.4 Frost damage caused by switching the appliance off

If you switch off the heating installation, parts of the heating installation may be damaged by frost.

- ▶ Do not disconnect the heat generator from the mains power.
- ▶ Leave the heating installation main switch in the "1" position.

2.3.5 Frost damage caused by excessively low room temperature

If the room temperature is set too low in individual rooms, sections of the heating installation might be damaged by frost.

- ▶ If you are absent during a frosty spell, ensure that the heating installation remains in operation and the rooms are warmed adequately.
- ▶ Please note the frost protection function.

2.4 CE label



The CE label documents that the controller complies with the fundamental requirements of the relevant directives.

2.5 Intended use

State-of-the-art

The controller is a state-of-the-art unit manufactured in accordance with recognised safety regulations.

Even so, in the event of inappropriate or non-intended use, damage to the appliance and other property may arise.

The controller controls a heating installation with a Vaillant heater with eBUS interface in a way that is room-controlled and time-dependent.



The controller can control the hot water generation of a connected domestic hot water cylinder.

Improper use

Any other use, or use beyond that specified, shall be considered improper use. Any direct commercial or industrial use is also deemed to be improper. The manufacturer/supplier is not liable for any resulting damage. The user alone bears the risk.

Improper use of any kind is prohibited.

Other applicable documents

Intended use includes the following:

- observance of accompanying operating, installation and servicing instructions for the Vaillant product as well as for other parts and components of the system
- compliance with all inspection and maintenance conditions listed in the instructions.

3 Overview of the equipment

3 Overview of the equipment

3.1 Unit design

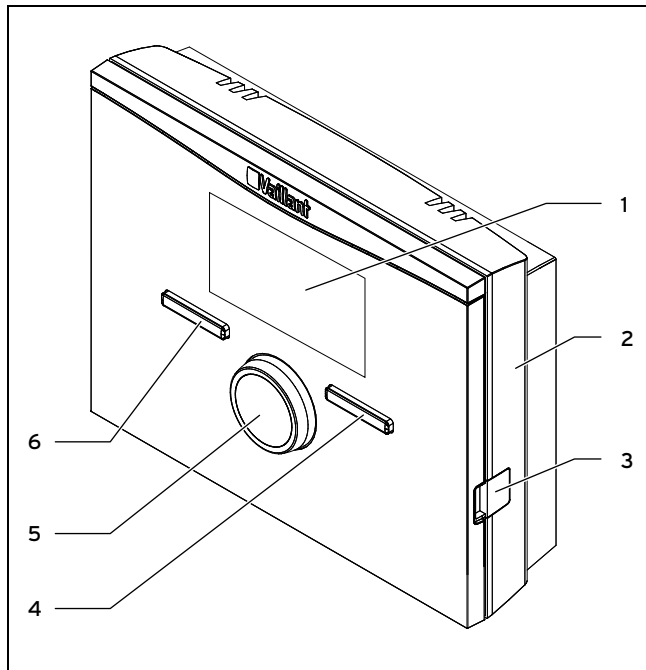

- | | | | |
|---|------------------|---|-----------------------|
| 1 | Display | 4 | Right selector button |
| 2 | Wall base | 5 | Rotary knob |
| 3 | Diagnosis socket | 6 | Left selector button |

3.2 Identification plate

The identification plate is located inside the controller and is not accessible from the outside.

3.3 Serial number

The 10-digit article number can be found in the serial number. You can view the serial number under **Menu** → **Information** **Serial number**. The article number is found in the second line of the serial number.

3.4 Control function

The controller controls the Vaillant heating system and hot water generation of a connected domestic hot water cylinder.

3.4.1 Heating installation

The controller is a room-temperature-controlled controller and must be installed in the living room. You can use the controller to set the desired temperature for different times of the day and for different days of the week. The temperature sensor measures the room temperature and sends the values to the controller. At lower room temperatures, the controller switches the heater on. Once the room temperature reaches the desired set temperature, the controller switches the heater off. The controller therefore reacts to the fluctuations of the room temperature and constantly controls the room temperature to the temperature that you have set.

Data exchange and power supply on the controller are via an eBUS interface. The controller can be equipped with the

Vaillant diagnosis software and the Vaillant Internet communication system for remote diagnosis and remote settings.

3.4.2 Hot water generation

You can use the controller to set the temperature and time for the hot water generation. The heater heats the water in the domestic hot water cylinder until it reaches the set temperature. You can set a time period during which hot water should be available in the domestic hot water cylinder.

3.4.3 VR 66 Control Centre

If a **VR 66** Control Centre is connected, you can control two independent heating circuits with just one **VRT 350** controller; e.g. one heating circuit is in the single-occupancy house and the second heating circuit is in a guest apartment in this building. In this case, one controller is always the main controller (Zone 1) and the other controller is the auxiliary controller (Zone 2). For Zone 1, which is controlled via the main controller, all of the functions are available to you. For Zone 2, you can use the auxiliary controller to set the desired temperature for different times of the day and different days of the week.

3.5 Frost protection function

The frost protection function protects the heating system and apartment from frost damage.

The frost protection function monitors the room temperature. If the room temperature

- falls below 5 °C, the controller switches the heater on and controls the system to a target room temperature of 5 °C.
- exceeds 5 °C, the heater is switched off but the room temperature monitoring remains active.

4 Operating

4.1 Operating structure

4.1.1 Access level for the operator

Through the access level for the operator, you access important information and set-up options which do not require any special prior knowledge. Via a menu structure, you can access configurable or read-only values.

4.1.2 Access level for the skilled tradesman

The skilled tradesman will set further values for the heating installation via the access level for the skilled tradesman. The settings may only be made by someone with specialist knowledge; this level is therefore code-protected.

4.1.3 Menu structure design

The menu structure of the controller is split into three levels. There are two selection levels and one setting level. From the basic display, you can access selection level 1 and, from there, you can access the menu structure for one level up or down. The setting level is accessed from the lowest selection level.

4 Operating

4.1.4 Basic display

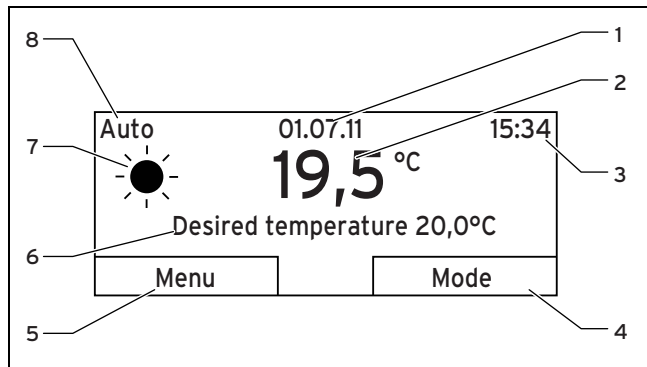



- | | |
|--|---|
| 1 Date | 5 Current function of the left-hand selector button (soft key function) |
| 2 Current room temperature | 6 Desired temperature |
| 3 Time | 7 Symbol for heating mode in Auto mode |
| 4 Current function of the right-hand selector button (soft key function) | 8 Mode set for the heating mode |

The basic display is the permanently visible display on the screen. The basic display shows the current settings and values of the heating installation. If you make a setting on the controller, the display on the screen switches from the basic display to the display for the new setting.

The basic display appears when you:

- press the left-hand selection button and thus exit selection level 1.
- do not operate the controller for more than 5 minutes.

4.1.4.1 Symbols for the heating mode in the Auto operating mode

Symbol	Meaning
	Heating mode within a set time period (comfort mode)
	Heating mode outside a set time period (set-back mode)

4.1.4.2 Soft key function

Both selector buttons have a soft key function. The current functions of the selector buttons are displayed in the bottom display line. Depending on the selection level selected in the menu structure, the list entry or the value,

- the current function of the left-hand selection button may differ.
- the current function of the right-hand selector button may differ.

If, for example, you press the left function key, the current function of the left function key switches from **Menu** to **Back**.

4.1.4.3 Menu

If you press the left-hand selector button, **Menu**, you switch from the basic display to selection level 1 of the menu structure.

4.1.4.4 Mode

If you press the right-hand selector button, **Operating mode**, you access the settings under **Operating mode** directly from the basic display. This is a quick way to modify the of **HEATING 1**.

4.1.4.5 Desired temperature

Depending on the operating mode, the desired temperature may be greyed out on the basic display. This is the case, for example, in **Summer mode**. As heating is not operational in **Summer mode**, and therefore the heating circuit is off, there is no desired temperature.

4.1.5 Selection level

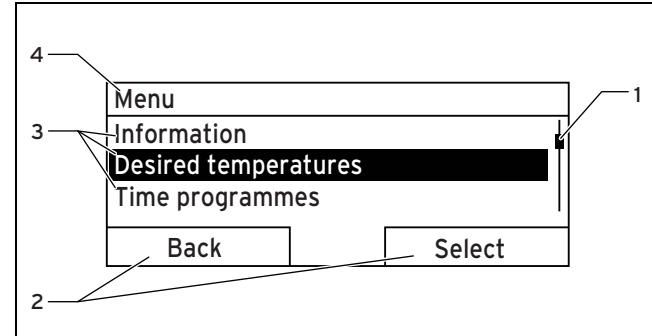

- | | | | |
|---|---|---|-------------------------------------|
| 1 | Scroll bar | 3 | Selection level list entries |
| 2 | Current functions of the right and left-hand selection buttons (soft key functions) | 4 | Current function or selection level |

Through the selection levels, you navigate to the setting level in which you wish to read or change settings.

4 Operating

4.1.6 Setting level

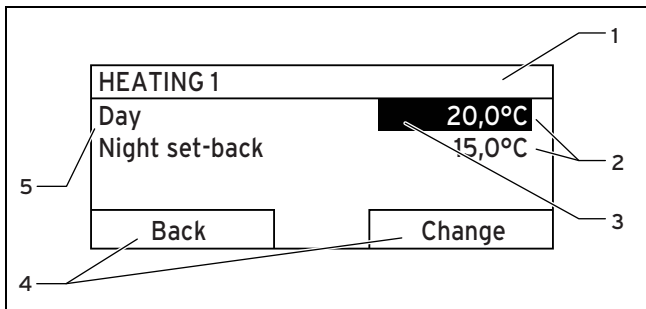

- | | |
|---------------------------------|---|
| 1 Current selection level | 4 Current functions of the right and left-hand selection buttons (soft key functions) |
| 2 Values | 5 Setting level |
| 3 Selection (current selection) | |

In the setting level, you can select the values you wish to read or change.

4.2 Operating concept

The controller is operated using two selection buttons and a rotary knob (→ Page 8).

The display shows a highlighted selection level, a setting level or a highlighted value with white font on a black background. A flashing highlighted value means that you can change the value.

If you do not operate the controller during a period of more than 5 minutes, the basic display appears again.

4.2.1 Operation in the basic display

From the basic display, you can change the **Desired day temperature** directly for the current day by turning the rotary knob.

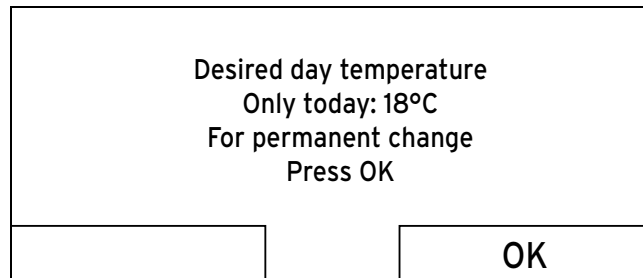

In the display, a request appears asking if you wish to change the **Desired day temperature** for only the current day or on a permanent basis.

4.2.1.1 To change the Desired day temperature for the current day only

- ▶ Turn the rotary knob to set the desired temperature.
 - ◁ The display switches back to the basic display after 12 seconds. The set desired temperature applies only until the end of the active time period of the current day.

4.2.1.2 Changing the Desired day temperature permanently

1. Turn the rotary knob to set the desired temperature.
2. Press the right-hand selection button, **OK**.
 - ◁ The display switches to the basic display. The new desired day temperature is applied permanently.

4.2.2 Operating example, changing the date

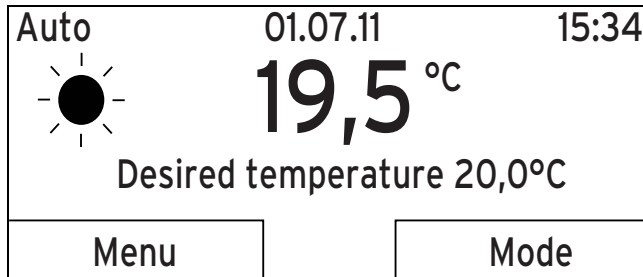

1. If the display does not show the basic display, press the left-hand selection button, **Back**, until the basic display appears again.
2. Press the left-hand selection button, **Menu**.
 - ◁ The controller is now in selection level 1. The left-hand selection button now has the function **Back** (to go back to the previous level), the right-hand selection button has the function **Select** (to select the highlighted menu option).

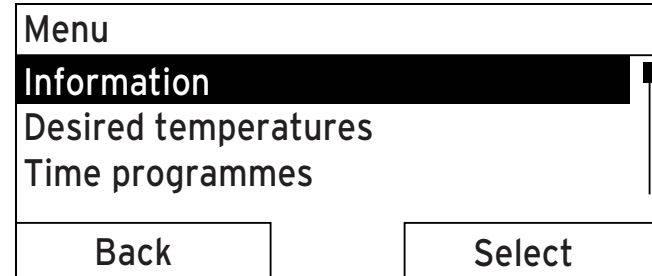

3. Turn the rotary knob until the **Basic settings** list entry is highlighted.

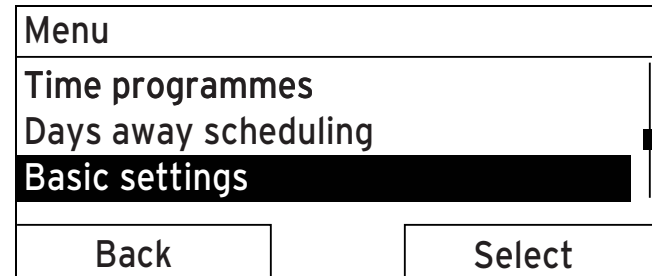

4. Press the right-hand selection button, **Select**.
 - ◁ The controller is now in selection level 2.

4 Operating

Basic settings	
Language	
Date/time	
Display	
Back	Select

5. Turn the rotary knob until the **Date/Time** list entry is highlighted.

Basic settings	
Language	
Date/time	
Display	
Back	Select

6. Press the right-hand selection button, **Select**.
- ◁ The controller is now in the **Date** setting level. The value for the day is highlighted. The left-hand selection button now has the function **Back** (to go back to the previous level), the right-hand selection button has the function **Change** (the value).

Date/time	
Date	13.03.11
Time	08:15
Daylight saving time	Off
Back	Change

7. Press the right-hand selection button, **Change**.
- ◁ The highlighted value starts to flash; you can now change the value by turning the rotary knob.
 - ◁ The left-hand selection button now has the function **Cancel** (the change); the right-hand selection button has the function **OK** (to confirm the change).

Date/time	
Date	13.03.11
Time	08:15
Daylight saving time	Off
Cancel	OK

8. Turn the rotary knob to change the value.

Date/time	
Date	14. 03 11
Time	08:15
Daylight saving time	Off
Cancel	OK

- Press the right-hand selection button, **OK**, to confirm the change.
 - ◀ The controller has stored the changed date.

Date/time	
Date	14. 03 11
Time	08:15
Daylight saving time	Off
Back	Change

- If the highlighted value that is flashing is correct, press the right-hand selection button **OK** again.
 - ◀ The left-hand selection button now has the function **Back**.

- Press the left-hand selector button **Back** repeatedly to revert back to the previous level and to access the basic display from selection level 1.

4 Operating

4.3 Overview of setting and read-out options

4.3.1 Overview of operating modes

The activated operating mode is shown in the top left of the basic display.

The right-hand selector button can be used to navigate from the basic display directly to the settings under **Operating mode**.

If you have activated an advanced function, the display indicates the advanced function.

If there is a second heating circuit, you can only set the operating modes using the main controller. The operating mode that is set applies for Zone 1 and for Zone 2.

Mode	Setting	Factory reset	Setting
Current mode			
Auto	Automatic mode	Active	
Summer	Summer mode	Not active	
Day	Comfort mode	Not active	
Night set-back	Set-back mode	Not active	
System OFF (Frost protection)	System OFF (Frost protection active)	Not active	
Advanced function			
Cylinder boost	Active, Not active	Not active	
Party function	Active, Not active	Not active	
1 day away from home	Active, Not active	Not active	

4.3.2 Overview of operating levels

Setting level	Values		Unit	Increment/Select	Factory reset	Setting
	Min.	Max.				
Information → System status →						
System						
Status	Current value					
Water pressure	Current value		bar			
<i>Domestic hot water</i>	<i>Current value</i>			<i>Charged, Charging</i>		
Heating 1						
Day temperature	Current value		°C	0.5	20	
	5	30				
Set-back temperature	Current value		°C	0.5	15	
	5	30				
Auto day temp to	Current value		hr:min			
<i>away from</i>	<i>Current value</i>		<i>dd.mm.yy</i>			
<i>away to</i>	<i>Current value</i>		<i>dd.mm.yy</i>			
Information → Contact details →						
<i>Installer phone number</i>	<i>Current values</i>					
Information → Serial number →						
If the VR 66 is connected, the functions shown in italics are only available for Zone 1 and these are only shown in the display for the main controller.						

4 Operating

Setting level	Values		Unit	Increment/Select	Factory reset	Setting
	Min.	Max.				
Appliance number	Permanent value					
Desired temperatures → HEATING 1 →						
Day Night set-back	5	30	°C	0.5	20 15	
Desired temperatures → Domestic hot water →						
<i>Domestic hot water</i>	<i>35</i>	<i>70</i>	°C	<i>1</i>	<i>60</i>	
Time programmes → HEATING 1 →						
Individual days and blocks				Mo, Tu, We, Th, Fr, Sa, Su and Mo - Fr, Sa - Su, Mo - Su	Mo - Fr: 06:00- 22:00 Sa: 07:30-23:30 Su: 07:30-22:00	
Time period 1: Start - End Time period 2: Start - End Time period 3: Start - End	00:00	24:00	hr:min	10 min		
Time programmes → Domestic hot water →						
<i>Individual days and blocks</i>				<i>Mo, Tu, We, Th, Fr, Sa, Su and Mo - Fr, Sa - Su, Mo - Su</i>	<i>Mo to Fr: 05:30- 22:00 Sa: 07:00-23:30 Su: 07.00-22.00</i>	
If the VR 66 is connected, the functions shown in italics are only available for Zone 1 and these are only shown in the display for the main controller.						

Setting level	Values		Unit	Increment/Select	Factory reset	Setting
	Min.	Max.				
<i>Time period 1: Start - End</i> <i>Time period 2: Start - End</i> <i>Time period 3: Start - End</i>	00:00	24:00	<i>hr:min</i>	<i>10 min</i>	<i>Mo to Fr: 05:30-22:00</i> <i>Sa: 07:00-23:30</i> <i>Su: 07:00-22:00</i>	
Days away scheduling →						
Start	01.01.00	31.12.99	<i>dd.mm.yy</i>	<i>Day.Month.Year</i>	01.01.10	
End	01.01.00	31.12.99	<i>dd.mm.yy</i>	<i>Day.Month.Year</i>	01.01.10	
Temperature	<i>Frost protection or 5</i>	30	°C	0.5	<i>Frost protection</i>	
Basic settings → Language →						
				Selectable language	English	
Basic settings → Date/Time →						
Date	01.01.00	31.12.99	<i>dd.mm.yy</i>	<i>Day.Month.Year</i>	01.01.10	
Time	00:00	24:00	<i>hr:min</i>	<i>10 min</i>	00:00	
Daylight saving				<i>Off, Auto</i>	<i>Off</i>	
Basic settings → Display →						
If the VR 66 is connected, the functions shown in italics are only available for Zone 1 and these are only shown in the display for the main controller.						

4 Operating

Setting level	Values		Unit	Increment/Select	Factory reset	Setting
	Min.	Max.				
Display contrast	01	15		1	8	
Basic settings → Offset →						
Room temperature	-3.0	3.0	K	0.5	0.0	
Basic settings → Set heating circuit name →						
Heating 1	1	10	Letter/number	A to Z, 0 to 9, space	Heating 1	
Basic settings → Factory reset (reset) →						
Time programmes				Yes, No	No	
Everything				Yes, No	No	
Installer level →						
000	999		1	000		
If the VR 66 is connected, the functions shown in <i>italics</i> are only available for Zone 1 and these are only shown in the display for the main controller.						

5 Operating and display functions

The path details given at the start of each function description indicate how you reach this function in the menu structure.

You can use the left-hand selection button **Menu** to set the operating and display functions.

The table "Overview of operating levels" and the overview of the menu tree show you which functions are available for Zone 2 via the auxiliary controller.

5.1 Information

5.1.1 Reading the system status

Menu → **Information** → **System status**

- Under **System status**, you can read a list containing the current values for the system: status, water pressure, hot water generation and the current values for **HEATING 1**.

There is also information under **System status**

- regarding the active time period (**Auto day temp until**),
- regarding exceptions in the timer programs that you may have set using the **Days away from home** function.

Only the desired temperatures for **Day temperature** and **Set-back temperature** can also be set directly under **System status**. All other values are set in other places in the menu structure, as described in the following sections.

5.1.2 Reading the list of status messages

Menu → **Information** → **System status** → **Status**

- If no service is required and no errors have occurred, the value **OK** is shown next to **Status**. If a service is required or an error has occurred, the value **Fault** is shown next to **Status**. In this case, the right-hand selector button has the function **Display**. If you press the right-hand selector button **Display**, the list of status messages is shown in the display.

5.1.3 Read skilled tradesman contact details

Menu → **Information** → **Contact details**

- If the skilled tradesman entered their company name and telephone number during the installation, you can read this data under **Contact details**.

5.1.4 Reading the serial number and article number

Menu → **Information** → **Serial number**

- **Serial number** shows the serial number of the controller, which the competent person may require you to tell him. The article number is found in the second line of the serial number.

5 Operating and display functions

5.2 Settings

5.2.1 Setting desired temperatures

This function is used to set the desired temperatures for **HEATING 1** and hot water generation.

5.2.1.1 Heating circuit



Caution.

Risk of damage due to frost.

If rooms are not adequately heated, this may cause damage to the building and to the heating installation.

- ▶ If you are absent during a frosty spell, ensure that the heating installation remains in operation and provides adequate frost protection.

Menu → Desired temperatures → HEATING 1

- You can set two different desired temperatures for the heating circuit.
- The desired **day temperature** is the temperature you wish to have in the rooms during the day or when you are at home (Comfort mode).
- The desired **night temperature** is the temperature that you wish to have in the rooms during the night or when you are away from home (Set-back mode).

5.2.1.2 Hot water generation



Danger!

Risk of being scalded by hot water.

There is a danger of scalding at the hot water draw-off points if the temperatures are greater than 60 °C. Young children and elderly persons are particularly at risk, even at lower temperatures.

- ▶ Select the temperature so that nobody is at risk.

Menu → Desired temperatures → Domestic hot water

- You can only use the controller's functions and setting options for hot water generation if a domestic hot water cylinder is connected to the heating installation.

You can set the desired **Hot water circuit** temperature for the hot water circuit.

5.2.2 Setting timer programs

5.2.2.1 Showing time periods for one day

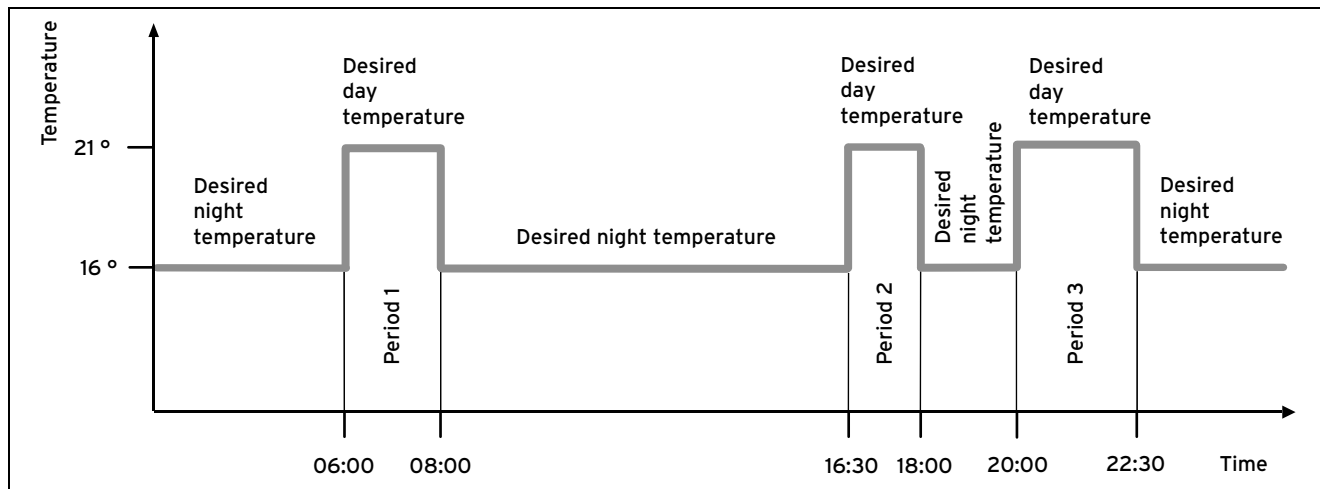

The **Time programmes** function can be used to set the time period for the heating circuit and hot water generation.

If you have not set any time periods, the controller uses the time periods set in the factory settings.

5 Operating and display functions

5.2.2.2 Setting time periods for days and blocks

For each day and block, you can set up to three time periods.

The time periods set for a day have priority over the time periods set for a block.

Desired temperature **Day**: 21 °C

Desired temperature **Night**: 16 °C

Time period 1: 06.00 - 08.00

Time period 2: 16.30 - 18.00

Time period 3: 20.00 - 22.30

Within the time periods, the controller brings the room temperature to the set desired **Day** temperature (Comfort mode).

Outside the time period, the controller brings the room temperature to the set desired **Set-back** temperature (Set-back mode).

Monday

Time period 1: 06.00 - 07.30

Saturday

Time period 1: 07.30 - 10.00

Time period 2: 12.00 - 23.30

Monday - Friday

Period 1: 06:30 - 08:00

Period 2: 12:00 - 13:00

Period 3: 17:00 - 22:00

Saturday - Sunday

Period 1: 08:00 - 22:00

5.2.2.3 Setting time programmes quickly

If, for example, you require a different time period for just one working day in the week, first set the times for the entire block **Monday - Friday**". Then set the different time period for the working day.

5.2.2.4 Displaying and changing different times in the block

Monday - Sunday	
Period 1:	!! : !! - !! : !!
Period 2:	!! : !! - !! : !!
Period 3:	!! : !! - !! : !!
Back	Select

If you view a block in the display and have defined a different period for a day in this block, then the display indicates the different times in the block with !!.

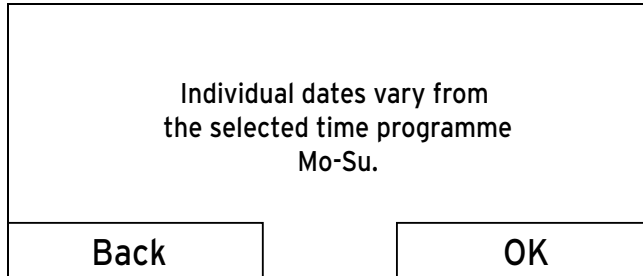

If you press the right-hand selection button **Select**, a message appears on the display which informs you about different periods. You do not need to adjust the times.

The set times for the block marked with !! can be viewed and changed if you press the right-hand selection button **OK** in the display.

5.2.2.5 For the heating circuit

Menu → Timer programs → HEATING 1

- The time programmes are only effective in the **Automatic mode** (→ Page 28). The desired temperature that you set in the **Desired temperatures** function applies in each set time period. Within the time period, the controller switches to Comfort mode and the heating circuit heats the connected rooms up to the desired **day temperature**. Outside this time period, the controller switches to the set-back mode and the heating circuit heats the connected rooms to the desired **set-back temperature**.

Set the time period for the heating circuit so that each time period:

- starts approx. 30 minutes before the time at which the rooms should reach the desired **day temperature**.
- ends approx. 30 minutes before the time at which the rooms should reach the desired **set-back temperature**.

5.2.2.6 For hot water generation

Menu → Timer programs → Hot water circuit

- You can only use the controller's functions and setting options for hot water generation if a domestic hot water cylinder is connected to the heating installation.

The timer programs are only effective for hot water generation in the **Automatic mode** and **Summer mode** operating modes.

In each set time period, the desired **Hot water circuit** temperature that you set in the **Desired temperatures** function applies. If, during the time period, the cylinder temperature drops by 5 °C below the desired **Hot water circuit** value, the domestic hot water cylinder is heated back up to the desired **Hot water circuit** temperature (recharged). At the end of a time period, the controller switches the hot water generation off until the start of the next time period.

Set the time periods for hot water generation so that each time period:

- Starts approx. 30 minutes before the time at which the water in the domestic hot water cylinder should have reached the desired **Hot water circuit** temperature.

5 Operating and display functions

- Ends approx. 30 minutes before the time at which you no longer need any hot water.

5.2.3 Days away from home scheduling

Menu → **Days away from home scheduling** → **HEATING 1**

- With this function, you can set a period with a start and end date and a temperature for days during which you are away from home. Thus, you do not need to change time periods for which you have set, for example, no reduction of the desired temperature over the course of the day.

Frost protection is activated.

While the **Days away from home scheduling** function is activated, it has priority over the set operating mode. At the end of the specified period, or if you cancel the function, the heating system returns to the pre-set mode.

5.2.4 Language selection



Note

During installation, the skilled tradesman sets the desired language. All functions are displayed in the set language.

Menu → **Basic settings** → **Language**

- If the language of e.g. a service technician differs from the set language, you can change the language using this function.



Caution.

It may not be possible to operate the controller if the wrong language is selected.

If you select a language that you do not understand, you can no longer read the text in the controller display and can no longer operate the controller.

- ▶ Only select a language that you understand.

However, if the text in the display should appear in a language that you do not understand, you can set a different language.

5.2.4.1 Set a language that you understand

1. Press the left-hand selection button repeatedly until the basic display appears.
2. Press the left-hand selection button again.
3. Rotate the rotary knob clockwise until the dotted line appears.
4. Then rotate the control knob anticlockwise until the second list entry above the dotted line is highlighted.
5. Press the right-hand selection button twice.
6. Turn the control knob (to the right or left) until you find a language you understand.
7. Press the right-hand selection button.

5.2.5 Setting the date

Menu → Basic settings → Date/Time → Date

- Select this function to set the current date. All controller functions that contain a date relate to the set date.

5.2.6 Setting the time

Menu → Basic settings → Date/Time → Time

- Select this function to set the current time. All controller functions that contain a time relate to the set time.

5.2.7 Changing over to daylight saving time

Menu → Basic settings → Date/Time → Day-light savings

- You can use this function to set whether the controller automatically changes over to daylight saving time, or whether you want to do this manually.
- **Auto:** The controller automatically changes over to daylight saving time.
- **Off:** You have to change over to daylight saving time manually.



Note

Daylight saving time means Central European summer time: Start = last Sunday in March, End = last Sunday in October.

5.2.8 Setting the display contrast

Menu → Basic settings → Display → Display contrast

- You can set the display contrast in relation to the brightness of the surroundings, to ensure that the display is clearly legible.

5.2.9 Setting the offset room temperature

Menu → Basic settings → Offset → Room temperature

- A thermometer is integrated in the controller for measuring the room temperature. If you have another thermometer in the same room and compare the values with each other, the temperature values may constantly differ from each other.

Example

One room thermometer constantly shows a temperature that is one degree higher than the current room temperature on the controller display. With the **Room temperature** function, you can offset the temperature difference in the controller display by setting a correction value of +1 K (1 K corresponds to 1 °C). K (Kelvin) is a unit for the temperature difference. Inputting a correction value affects the room temperature compensator.

5.2.10 Changing heating circuit naming

Menu → Basic settings → Change heating circuit naming

- You can now modify the factory-specified heating circuit names as you wish. The name is limited to 10 characters.

5 Operating and display functions

5.2.11 Resetting to factory setting

You can reset the settings for the **Time programmes** or for **Everything** to the factory setting.

Menu → **Basic settings** → **Factory reset** → **Time programmes**

- With **Timer programs**, you reset all the settings you have made in the **Timer programs** function to the default setting. All other settings that include times, such as **Date/Time**, are not affected.

While the controller is resetting the timer program settings to the default settings, **In process** is shown on the display. The basic display is then displayed.



Caution. **Risk of a malfunction.**

The **Everything** function restores all settings to the factory settings, including those set by the skilled tradesman. It may be the case that it is no longer possible to operate the heating installation after this.

- ▶ Arrange for the skilled tradesman to reset all settings to factory settings.

Menu → **Basic settings** → **Factory reset** → **Everything**

- While the controller is resetting the settings to the factory settings, **in process** is shown on the display. Then the

installation assistant appears in the display, which only the skilled tradesman may operate.

5.2.12 Installer level

The Installer level is reserved for the skilled tradesman and is therefore protected by an access code. At this operating level, the skilled tradesman can make the necessary settings.

5.3 Operating modes

Use the right-hand selector button, **Operating mode** to set the mode directly.

The path details given at the start of each mode description indicate how you reach this mode in the menu structure.

5.3.1 Operating modes for the heating circuit

5.3.1.1 Automatic mode

Operating mode → **Automatic mode**

- The automatic mode controls the heating circuit in accordance with the set desired temperature and the set time periods.

Within the time periods, the controller brings the room temperature to the set desired **Day** temperature (Comfort mode).

Outside the time period, the controller brings the room temperature to the set desired **Set-back** temperature (Set-back mode).

5.3.1.2 Summer mode

Operating mode → Summer mode

- The heating function is switched off for the heating circuit and the frost protection function is active.

The hot water generation controls the controller in accordance with the time period that has been set for this purpose.

5.3.1.3 Comfort mode

Operating mode → Comfort mode

- The **Comfort mode** operating mode brings the heating circuit to the set desired **day temperature**, without taking account of a time period.

5.3.1.4 Set-back mode

Operating mode → Set-back mode

- The **Set-back mode** operating mode controls the heating circuit to the set desired **Set-back** temperature, without taking time periods into consideration.

5.3.1.5 System OFF

Operating mode → System OFF

- The heating function is switched off. The frost protection function is activated.

5.3.2 Modes for hot water production

The operating mode for hot water generation corresponds to the heating circuit operating mode that has been set. You cannot set a different operating mode.

5.3.2.1 Automatic mode

The automatic mode controls the hot water generation in accordance with the set desired temperature for **Hot water circuit** and the set time periods. In the **Timer programs** function, you have set time periods for hot water generation. If you have not set any time periods, the controller uses the time period set in the factory settings for hot water generation.

Within the time period, hot water generation is switched on and maintains the hot water in the DHW cylinder at the pre-set temperature. Outside the period, hot water generation is switched off.

5.3.2.2 Summer mode

The summer mode controls the hot water generation in accordance with the set desired temperature for **Hot water circuit** and the set time periods. In the **Timer programs** function, you have set time periods for hot water generation. If you have not set any time periods, the controller uses the time period set in the factory settings for hot water generation.

Within the time period, hot water generation is switched on and maintains the hot water in the DHW cylinder at the pre-

5 Operating and display functions

set temperature. Outside the period, hot water generation is switched off.

5.3.2.3 Comfort mode

The comfort mode controls the hot water generation in accordance with the set desired temperature for **Hot water circuit** without taking time periods into account.

5.3.2.4 Set-back mode

Hot water generation is switched off and the frost protection function is activated.

5.3.2.5 System off

Hot water generation is switched off and the Frost protection function is active.

5.4 Special operating modes

The advanced functions can be activated directly from any mode using the right-hand selector button **Operating mode**.

The path details given at the start of each advanced function description indicate how you can access this advanced function in the menu structure.

5.4.1 Cylinder boost

Operating mode → Cylinder boost

- If you have switched off hot water generation or require hot water outside a time period, activate the **Cylinder**

boost advanced function. The advanced function heats the water in the domestic hot water cylinder once, until the set desired **Hot water circuit** temperature is reached or until you cancel the advanced function early. The heating system will then return to the pre-set mode.

5.4.2 Party

Operating mode → Party function

- If you want to switch on the heating circuit and hot water generation temporarily, e.g. during a party, activate the advanced function **Party**.

This means you do not need to change the settings on the heating system for short periods of time. The advanced function brings the room temperature to the set desired **Day** temperature, in accordance with the set time periods.

If the display shows **Party function active**, you can use the rotary knob to set the desired **Day** temperature for the heating circuit.

The advanced function is deactivated when the next time period is reached or if you cancel the advanced function early. The heating system will then return to the pre-set mode.

5.4.3 1 day away from home

Operating mode → 1 Day away from home

- If you are only away from home for one day, e.g. for a day trip, activate the **1 Day away from home** advanced function. This means you do not need to change the time

periods that you have set by increasing the room temperature during the day, for example. This advanced function brings the room temperature to the desired **Set-back** temperature.

Hot water generation is switched off and frost protection is activated.

If the display shows **1 Day away from home active**, you can use the rotary knob to set the desired **Set-back** temperature for the heating circuit.

The advanced function is automatically deactivated after 24:00 hours or if you cancel the advanced function first. The heating system will then return to the pre-set mode.

5.5 Messages

5.5.1 Service message

If a service is required, the controller displays a service message in the display.



Caution.

Risk of damage to the heating installation due to failure to perform maintenance work.

A service message indicates that the heating installation must be serviced by the skilled tradesman. Failure to observe these service messages could lead to material damage or failure of the heating installation.

- ▶ If the controller displays a service message, inform a skilled tradesman.

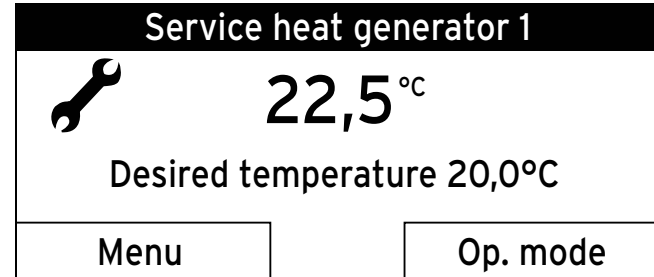

The following service messages may appear:

- **Service heat generator 1**
- **Service** (of the heating installation)

5.5.2 Fault message

If a fault occurs in the heating installation, the controller displays a fault message in the display.

6 Service and troubleshooting



Caution.

Risk of damage to the heating installation due to failure to perform troubleshooting work.

A fault message indicates that the skilled tradesman must perform troubleshooting or repair work on the heating installation. Failure to observe these fault messages could lead to material damage or failure of the heating installation.

- ▶ If the controller displays a fault message, inform a skilled tradesman.

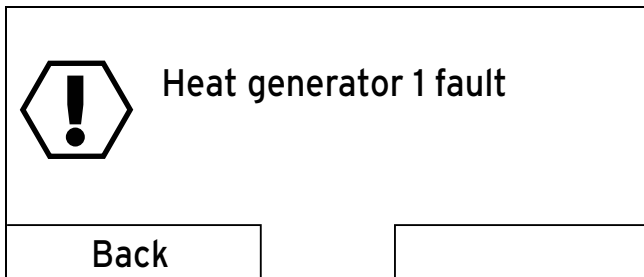

If the controller shows a fault message in the display instead of the basic display and you press the left-hand selection button **Back** then the basic display appears again.

You can also read current fault messages under **Menu** → **Information** → **System status** → **Status**. As soon as a fault

message for the heating installation appears, the **Status** setting level will display **Fault**. In this case, the right-hand function key has the function **Display**.

6 Service and troubleshooting

6.1 Cleaning the controller

1. Clean the casing of the controller with a damp cloth.
2. Never use scouring or cleaning agents which could damage the operator control elements or the display.

6.2 Detecting and rectifying faults

Fault	Cause	Remedy
Display is dark	Unit fault	– Switch off the mains switch on the heater for approx. 1 minute and then switch it on again – If the error is still present, inform the competent person
No changes in the display via the rotary knob		
No changes in the display via the selector buttons		

7 Decommissioning

7.1 Replacing the controller

If the controller of the heating system needs to be replaced, the heating system must be shut down.

This work should be conducted by a skilled tradesman.

7.2 Recycling and disposal

The controller and the associated transport packaging consist largely of recyclable materials.

Unit



If your Vaillant unit is identified with this symbol, it does not belong with your household waste at the end of its useful life.

- ▶ In this case, make sure that the Vaillant unit and any accessories are properly disposed of at the end of their useful life.

As this Vaillant unit is covered by the law regarding the marketing, return and environmentally friendly disposal of electrical and electronic equipment (ElektroG in Germany), the unit can be disposed of free of charge at a municipal collection point.

Packaging

The approved qualified servicing company that installed the unit will dispose of the transport packaging.

8 Warranty and customer service

8.1 Warranty

We only grant a Vaillant manufacturers warranty if a suitably qualified engineer has installed the system in accordance with Vaillant instructions. The system owner will be granted a warranty in accordance with the Vaillant terms and conditions. All requests for work during the guarantee period must be made to Vaillant Service Solutions (0330 100 3461).

8.2 Customer service

To ensure regular servicing, it is strongly recommended that arrangements are made for a Maintenance Agreement.

Please contact Vaillant Service Solutions for further details: 0330 100 3461

9 Technical data

9 Technical data

9.1 Controller

Designation	Value
Operating voltage U _{max}	24 V
Current consumption	< 50 mA
Supply line cross-section	0.75 ... 1.5 mm ²
Level of protection	IP 20
Protection class	III
Maximum permissible ambient temperature	50 °C
Height	97 mm
Width	147 mm
Depth	50 mm

0020135485_01

Vaillant Ltd

Nottingham Road ■ Belper ■ Derbyshire ■ DE56 1JT

Telephone 01773 300 3461 ■ Vaillant (UK) Limited • A-H-C-E-A-I-F

Spares Technical Enquiries 01773 59 66 15

info@vaillant.co.uk ■ technicalspares@groupservice.co.uk

www.vaillant.co.uk

