

For the operator

## Operating instructions



ecoFIT pure

612 - 630

GB, IE

**Publisher/manufacture**

**Vaillant GmbH**

Berghauser Str. 40 ■ D-42859 Remscheid  
Tel. +49 21 91 18-0 ■ Fax +49 21 91 18-2810  
info@vaillant.de ■ www.vaillant.de



# Contents

## Contents

<b>1</b>	<b>Safety</b> .....	<b>3</b>	<b>5</b>	<b>Troubleshooting</b> .....	<b>13</b>
1.1	Action-related warnings .....	3	5.1	Detecting and rectifying faults.....	13
1.2	Intended use .....	3	5.2	Calling up (Live monitor) status codes .....	13
1.3	General safety information.....	4	<b>6</b>	<b>Care and maintenance</b> .....	<b>14</b>
<b>2</b>	<b>Notes on the documentation</b> .....	<b>7</b>	6.1	Maintenance .....	14
2.1	Observing other applicable documents .....	7	6.2	Caring for the product.....	14
2.2	Storing documents.....	7	6.3	Reading maintenance messages .....	14
2.3	Applicability of the instructions.....	7	6.4	Checking the condensate drain pipework and tundish.....	14
<b>3</b>	<b>Product description</b> .....	<b>7</b>	<b>7</b>	<b>Decommissioning</b> .....	<b>14</b>
3.1	Front view .....	7	7.1	Temporarily decommissioning the product.....	14
3.2	Control elements.....	7	7.2	Permanently decommissioning the product.....	14
3.3	Displayed symbols.....	8	<b>8</b>	<b>Recycling and disposal</b> .....	<b>14</b>
3.4	Information on the identification plate .....	8	<b>9</b>	<b>Guarantee and customer service</b> .....	<b>15</b>
3.5	Serial number .....	9	9.1	Guarantee.....	15
3.6	CE label .....	9	9.2	Customer service.....	15
3.7	Benchmark.....	9	<b>Appendix</b> .....	<b>16</b>	
<b>4</b>	<b>Operation</b> .....	<b>10</b>	<b>A</b>	<b>Status codes – Overview</b> .....	<b>16</b>
4.1	Operating concept .....	10	<b>B</b>	<b>Troubleshooting</b> .....	<b>16</b>
4.2	Basic display.....	10			
4.3	Adjustment and display levels .....	10			
4.4	Cabinet-type casing .....	10			
4.5	Opening the isolator devices .....	10			
4.6	Starting up the product .....	11			
4.7	Switching on the product .....	11			
4.8	Setting the heating flow temperature .....	11			
4.9	Setting the hot water temperature .....	11			
4.10	Switching off the product's functions .....	11			
4.11	Guaranteeing the correct filling pressure of the heating system .....	12			
4.12	Protecting the heating installation against frost .....	13			
4.13	Switching the product to standby mode .....	13			

## 1 Safety

### 1.1 Action-related warnings

#### Classification of action-related warnings

The action-related warnings are classified in accordance with the severity of the possible danger using the following warning signs and signal words:

#### Warning symbols and signal words



#### **Danger!**

Imminent danger to life or risk of severe personal injury



#### **Danger!**

Risk of death from electric shock



#### **Warning.**

Risk of minor personal injury



#### **Caution.**

Risk of material or environmental damage

### 1.2 Intended use

There is a risk of injury or death to the user or others, or of damage to the product and other property in the event of improper use or use for which it is not intended.

The product is intended as a heat generator for closed heat-

ing installations and for hot water generation.

Intended use includes the following:

- observance of the operating instructions included for the product and any other system components
- compliance with all inspection and maintenance conditions listed in the instructions.

This product can be used by children aged from 8 years and above and persons with reduced physical, sensory or mental capabilities or lack of experience and knowledge if they have been given supervision or instruction concerning use of the product in a safe way and understand the hazards involved. Children must not play with the product. Cleaning and user maintenance work must not be carried out by children unless they are supervised.

Any other use that is not specified in these instructions, or use beyond that specified in this document shall be considered improper use. Any direct commercial or industrial use is also deemed to be improper.

#### **Caution.**

Improper use of any kind is prohibited.

# 1 Safety

## 1.3 General safety information

### 1.3.1 Installation by competent persons only

The installation, inspection, maintenance and repair of the product, as well as the gas ratio settings, must only be carried out by a competent person.

### 1.3.2 Danger caused by improper operation

Improper operation may present a danger to you and others, and cause material damage.

- ▶ Carefully read the enclosed instructions and all other applicable documents, particularly the "Safety" section and the warnings.
- ▶ Only carry out the activities for which instructions are provided in these operating instructions.

### 1.3.3 Risk of death from escaping gas

What to do if you smell gas in the building:

- ▶ Avoid rooms that smell of gas.
- ▶ If possible, open doors and windows fully and ensure adequate ventilation.
- ▶ Do not use naked flames (e.g. lighters, matches).
- ▶ Do not smoke.

- ▶ Do not use any electrical switches, mains plugs, door-bells, telephones or other communication systems in the building.
- ▶ If it is safe to do so, close the emergency control valve or the main isolator.
- ▶ If possible, close the gas isolator cock on the product.
- ▶ Warn other occupants in the building by yelling or banging on doors or walls.
- ▶ Leave the building immediately and ensure that others do not enter the building.
- ▶ Notify the gas supply company or the National Grid +44 (0) 800 111999 by telephone once you are outside of the building.

### 1.3.4 Risk of death due to a blocked or leaking flue gas pipe

What to do if you smell flue gas in the property:

- ▶ Open all accessible doors and windows fully to provide ventilation.
- ▶ Switch off the product.
- ▶ Inform a competent person.



### 1.3.5 Risk of death due to explosive and flammable materials

- ▶ Do not use or store explosive or flammable materials (e.g. petrol, paper, paint) in the installation room of the product.

### 1.3.6 Risk of death due to changes to the product or the product environment

- ▶ Never remove, bridge or block the safety devices.
- ▶ Do not tamper with any of the safety devices.
- ▶ Do not damage or remove any seals on components.
- ▶ Do not make any changes:
  - The product itself
  - to the gas, air, water and electricity supplies
  - to the entire flue gas installation
  - to the entire condensate drain system
  - to the expansion relief valve
  - to the drain pipework
  - to constructional conditions that may affect the operational reliability of the product

### 1.3.7 Risk of corrosion damage due to unsuitable combustion and room air

Sprays, solvents, chlorinated cleaning agents, paint, adhesives, ammonia compounds, dust or similar substances may lead to corrosion on the product and in the air/flue pipe.

- ▶ Ensure that the supply of combustion air is always free of fluorine, chlorine, sulphur, dust, etc.
- ▶ Ensure that no chemical substances are stored at the installation site.

### 1.3.8 Risk of material damage caused by frost

- ▶ Ensure that the heating installation always remains in operation during freezing conditions and that all rooms are sufficiently heated.
- ▶ If you cannot ensure the operation, have a competent person drain the heating installation.



## 1 Safety

### **1.3.9 Risk of injury and material damage due to maintenance and repairs carried out incorrectly or not carried out at all**

- ▶ Never attempt to carry out maintenance work or repairs on your product yourself.
- ▶ Faults and damage should be immediately rectified by a competent person.
- ▶ Adhere to the maintenance intervals specified.



# Notes on the documentation 2

## 2 Notes on the documentation

### 2.1 Observing other applicable documents

- ▶ You must observe all operating instructions enclosed with the system components.

### 2.2 Storing documents

- ▶ Keep this manual and all other applicable documents safe for future use.

### 2.3 Applicability of the instructions

These instructions apply only to:

#### Product article number

	Article number	Gas Council Number
VU 126/6-3 (H-GB)	0010020395	41-694-03
VU 156/6-3 (H-GB)	0010020396	41-694-04
VU 186/6-3 (H-GB)	0010020397	41-694-05
VU 256/6-3 (H-GB)	0010020398	41-694-06
VU 306/6-3 (H-GB)	0010020399	41-694-07

## 3 Product description

### 3.1 Front view

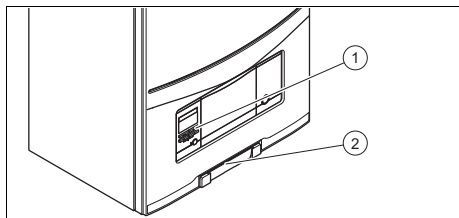

- 1 Control elements      2 Plate with serial number on the rear



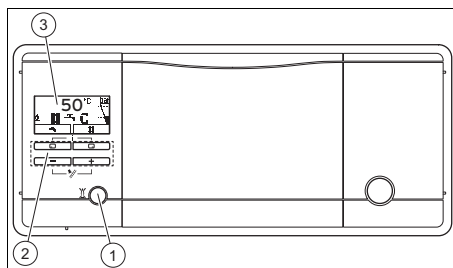

### 3.2 Control elements

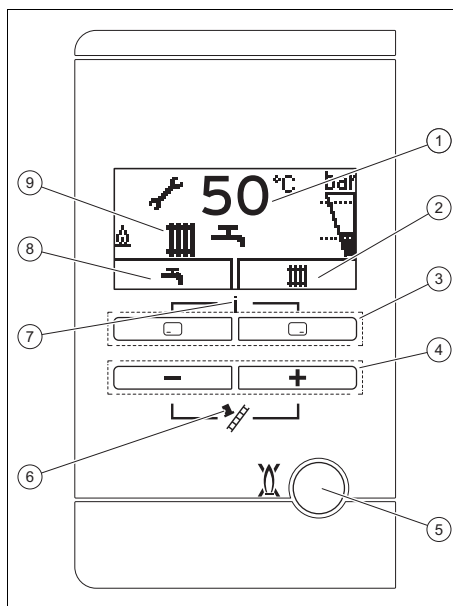

- 1 Fault clearance key       2 Operating buttons  
3 Display

#### 3.2.1 Operator control panel











- 1 Current heating flow temperature, operating mode, fault code or additional information  
2 Current assignment of the right-hand selection button  
3 Left- and right-hand selection buttons    
4  and  button  
5 Fault clearance key

## 3 Product description

- |   |   |   |  |
|---|---|---|--|
| 6 | Maximum output (only used for Austria, Germany and Switzerland) | 8 | Current assignment of the left-hand selection button |
| 7 | Access to the menu for additional information                   | 9 | Active operating status                              |

### 3.3 Displayed symbols

Symbol	Meaning	Explanation
	Burner operating correctly	Burner on
	Current filling pressure of the heating system The dashed lines show the permitted range	<ul style="list-style-type: none"> <li>– Permanently on: Filling pressure in the permitted range</li> <li>– Flashing: Filling pressure outside the permitted range</li> </ul>
	Heating mode active	<ul style="list-style-type: none"> <li>– Permanently on: Heating mode heat requirement</li> <li>– Flashing: Burner on in heating mode</li> </ul>
	Hot water generation active	<ul style="list-style-type: none"> <li>– Permanently on: In draw-off mode before burner is on</li> <li>– Flashing: Burner on in draw-off mode</li> </ul>
	Maintenance required	Information on the maintenance message in the "Live Monitor"
	Summer mode active Heating mode is switched off	

Symbol	Meaning	Explanation
	Burner anti-cycling time is active	To avoid the need for frequent switching on and off (increases the product's working life).
 F.XX	Fault in the product	Fault in the product. Appears instead of the basic display.

### 3.4 Information on the identification plate



The identification plate is mounted on the underside of the product in the factory.

The identification plate keeps record of the country in which the product is to be installed.

Information on the identification plate	Meaning
	Barcode with serial number
Serial number	<p>For quality control purposes; 3rd and 4th digits = year of production</p> <p>For quality control purposes; 5th and 6th digits = week of production</p> <p>For identification purposes; 7th to 16th digits = product article number</p> <p>For quality control purposes; 17th to 20th digits = place of manufacture</p>
ecoFIT pure	Product designation
2H, G20 – 2 kPa (20 mbar)	Factory setting for type of gas and gas connection pressure
Cat.	Unit category
Condensing technology	Efficiency class of the boiler in accordance with EC Directive 92/42/EEC
Type: Xx3(x)	Permissible flue gas connections



## Product description 3

Information on the identification plate	Meaning
PMS	Maximum water pressure in heating mode
PMW	Maximum water pressure in hot water handling mode
V/Hz	Electrical connection
W	Max. electrical power consumption
IP	Level of protection
	Heating mode
	Hot water generation
$P_n$	Nominal heat output range in heating mode
$P_{nc}$	Nominal heat output range in heating mode (condensing technology)
$P$	Nominal heat output range in hot water handling mode
$Q_n$	Nominal heating load range in heating mode
$Q_{nw}$	Nominal heating load range in hot water handling mode
$T_{max.}$	Max. flow temperature
NOx	NOx class for the product
Code (DSN)	Specific product code
	Read the instructions.
GC no.	Gas council number

### 3.5 Serial number

The serial number is located on a plastic plate at the bottom of the front casing.

### 3.6 CE label



The CE label shows that the products comply with the basic requirements of the applicable directives as stated on the identification plate.

The declaration of conformity can be viewed at the manufacturer's site.

### 3.7 Benchmark



Vaillant is a licensed member of the Benchmark Scheme which aims to improve the standards of installation and commissioning of domestic heating and hot water systems in the UK and to encourage regular servicing to optimise safety, efficiency and performance.

Benchmark is managed and promoted by the Heating and Hotwater Industry Council. For more information visit [www.benchmark.org.uk](http://www.benchmark.org.uk).

- Please ensure that the installer has fully completed the Benchmark Checklist on the inside back pages of the installation instructions supplied with the product and that you have signed it to say that you have received a full and clear explanation of its operation. The installer is legally required to complete a commissioning checklist as a means of complying with the appropriate Building Regulations (England and Wales).







All installations must be notified to Local Area Building Control either directly or through a Competent Persons Scheme. A Building Regulations Compliance Certificate will then be issued to the customer who should, on receipt, write the Notification Number on the Benchmark Checklist. This product should be serviced regularly to optimise its safety, efficiency and performance. The service engineer should complete the relevant Service Record on the Benchmark Checklist after each service.



The Benchmark Checklist will be required in the event of any warranty.

## 4 Operation

### 4 Operation

#### 4.1 Operating concept

Op-er-ator control element	Function
	<ul style="list-style-type: none"> <li>– Setting the hot water temperature</li> <li>– Cancelling the activation of an operating mode</li> <li>– Cancelling a change to a set value</li> <li>– Going one selection level higher</li> </ul>
	<ul style="list-style-type: none"> <li>– Setting the heating flow temperature</li> <li>– Reading the system pressure</li> <li>– Activating the comfort mode</li> <li>– Activating the operating mode</li> <li>– Confirm setting</li> <li>– Going one selection level lower</li> </ul>
 +  at the same time	<ul style="list-style-type: none"> <li>– Calling up the menu</li> </ul>
 or 	<ul style="list-style-type: none"> <li>– Reducing or increasing the set value</li> <li>– Scrolling through menu entries</li> </ul>

The current function of the  and  buttons is shown in the display.

Adjustable values are always displayed as flashing.

You must always confirm a change to a value. Only then is the new setting saved. You can press  to cancel a procedure at any time.

#### 4.2 Basic display

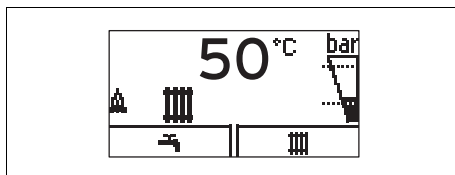

The basic display shows the current condition of the product. If you press a selection

button, the activated function is displayed in the display.

The functions that are available depend on whether a controller is connected to the product.

You can switch back to the basic display by:

- Pressing  to exit the selection levels
- Not pressing any button for longer than 15 minutes.

If there is an error message present, the basic displays switches to the error message.

#### 4.3 Adjustment and display levels

The product has two adjustment and display levels.

The end user level contains information and setting options that you require as the end user.

The installer level is reserved for the competent person. It is protected by a code. Only competent persons may change any settings in the installer level.

#### 4.4 Cabinet-type casing

Enclosing the product in cabinet-type casing requires compliance with the applicable design instructions.

If you require cabinet-type casing for your product, consult a heating specialist company. Never, under any circumstances, enclose the product yourself.

#### 4.5 Opening the isolator devices

1. Ask the competent person who installed the product to explain to you where these isolator devices are located and how to handle them.
2. Open the gas isolator cock fully.
3. Open the service valves in the heating installation's flow and return.

**Applicability:** Product with connected domestic hot water cylinder

- ▶ Open the cold water stop valve.

## 4.6 Starting up the product

- ▶ Only start up the product once the casing has been completely closed.

## 4.7 Switching on the product

- ▶ Switch on the product via the main switch installed on-site.

## 4.8 Setting the heating flow temperature



1. Press  (III).
  - ◁ The target value of the heating flow temperature appears on the display.



### Note

The competent person may have adjusted the maximum possible temperature.

**Conditions:** No controller connected

- ▶ Use  or  to set the required heating flow temperature.
- ▶ Confirm by pressing .

**Conditions:** Controller connected

- ▶ Set the maximum possible heating flow temperature on the product.
- ▶ Confirm by pressing .
- ▶ Set the required heating flow temperature on the controller (→ Controller operating instructions).

## 4.9 Setting the hot water temperature





### Warning.



### Risk of being scalded by hot water.

To protect against Legionella, the hot water can be heated up to above 60 °C at pre-defined times.



- ▶ Have a competent person inform you about the measures that should be taken to protect against Legionella in your system.

1. Press  (  ).
  - ◁ The set hot water temperature flashes in the display.

**Conditions:** No controller connected



- ▶ Change the hot water temperature by pressing  or .
- ▶ Confirm by pressing .

**Conditions:** Controller connected



- ▶ Use  to set the maximum possible hot water temperature on the product.
- ▶ Confirm by pressing .
- ▶ Set the required hot water temperature on the controller (→ Controller operating instructions).

## 4.10 Switching off the product's functions

### 4.10.1 Switching off heating mode (Summer mode)

1. To switch off heating mode without switching off the hot water generation, press  (III).
  - ◁ The value of the heating flow temperature appears in the display.
2. Use the  button to set the heating flow temperature to **Off**.

## 4 Operation

3. Confirm by pressing 
  - ◁ Heating mode is switched off.
  - ◁ The  symbol appears in the display.

### 4.11 Guaranteeing the correct filling pressure of the heating system

#### 4.11.1 Checking the filling pressure of the heating installation



##### Note

To ensure that the heating installation operates smoothly, the filling pressure when the heating installation is cold must be between 0.10 MPa and 0.20 MPa (1.0 bar and 2.0 bar) or lie between the two dashed lines in the bar graph display.

If the heating installation extends over several storeys, a higher filling pressure may be required for the heating installation. Ask a competent person for details.

In addition, the  symbol appears after approx. one minute.

If the filling pressure in the heating installation falls below 0.05 MPa (0.5 bar), then the product switches off. The display alternates between the fault message **F.22** and the current filling pressure.

1. Press  twice.
  - ◁ The values for the current filling pressure and for the minimum and maximum filling pressures appear in the display.

2. Check the filling pressure in the display.

##### 1 / 2

System pressure: 0.10 ... 0.20 MPa  
(1.00 ... 2.00 bar)

The filling pressure is in the intended pressure range.

##### 2 / 2

Filling pressure: < 0.08 MPa  
(< 0.80 bar)

- ▶ Fill the heating installation.  
(→ Page 12)
  - ◁ If you have topped up the installation with sufficient heating water, the display automatically disappears after 20 seconds.

#### 4.11.2 Filling the heating installation



##### Caution.

**Risk of material damage due to heating water that is extremely calciferous or corrosive or contaminated by chemicals.**

Unsuitable tap water damages the seals and diaphragms, blocks components in the product and heating installation through which the water flows and causes noise.

- ▶ Only fill the heating installation with suitable heating water.

1. Ask a competent person where the filling cock is located.
2. Connect the filling tap to a heating water supply in the way you were told by the competent person.
3. Open all radiator valves (thermostatic radiator valves) of the heating installation.
4. Open the heating water supply.
5. Turn the filling cock on slowly and allow water to flow in until the required filling pressure has been reached.
6. Close the heating water supply.
7. Purge all radiators.

8. Check the filling pressure in the display.
9. Top up with more water if necessary.
10. Close the filling cock.
11. Return to the basic display.  
(→ Page 10)

## 4.12 Protecting the heating installation against frost

### 4.12.1 Frost protection function



#### Caution.

#### Risk of material damage due to frost.

The frost protection function cannot guarantee flow through the entire heating installation, which means that parts of the heating installation may freeze and therefore become damaged.

- ▶ During a period of frost, ensure that the heating installation remains in operation and that all rooms are sufficiently heated, even when you are away.



#### Note

To keep the frost protection devices active, you should switch your product on and off using the controller, if one is provided.

If the heating flow temperature falls below 5 °C when the on/off button is on, the product comes into operation and heats the circulating water to approx. 30 °C on both the heating side and the hot water side (if available).

### 4.12.2 Draining the heating installation

When the unit is switched off for an extended period, frost protection can be guar-

anteed by completely draining the heating installation and the product.

- ▶ Consult a competent person about this.

## 4.13 Switching the product to standby mode



- ▶ Press the fault clearance key for less than three seconds.
  - ◁ The display shows **OFF** and goes out.
  - ◁ The product is now in standby mode.
  - ◁ The product's frost protection function is activated.
  - ◁ The main power supply is not interrupted. The product continues to be supplied with power.

# 5 Troubleshooting

## 5.1 Detecting and rectifying faults

- ▶ If faults occur, proceed in accordance with the table in the appendix. Troubleshooting (→ Page 16)
- ▶ If the fault cannot be eliminated using the specified measures or if fault messages (**F.xx**) occur, contact a competent person.

## 5.2 Calling up (Live monitor) status codes

- ▶ Press  and  at the same time. Status codes – Overview (→ Page 16)
  - ◁ The current operating status (status code) is shown on the display.

## 6 Care and maintenance

### 6 Care and maintenance

#### 6.1 Maintenance

An annual inspection of the product carried out by a competent person is a prerequisite for ensuring that the product is permanently ready and safe for operation, reliable, and has a long working life.

#### 6.2 Caring for the product



**Caution.**  
**Risk of material damage caused by unsuitable cleaning agents.**

- ▶ Do not use sprays, scouring agents, detergents, solvents or cleaning agents that contain chlorine.

- 
- ▶ Clean the casing with a damp cloth and a little solvent-free soap.

#### 6.3 Reading maintenance messages

If the  symbol is shown in the display, the product requires maintenance work.

The product is not in fault mode but continues to operate.

- ▶ Consult a competent person about this.
- ▶ If the water pressure is flashing at the same time, simply add more heating water.

#### 6.4 Checking the condensate drain pipework and tundish

The condensate drain pipework and tundish must always be penetrable.

- ▶ Regularly check the condensate drain pipework and tundish for faults and, particularly, for blockages.

You must not be able to see or feel any obstructions in the condensate drain pipework and tundish.

- ▶ If you notice a fault, have it rectified by a competent person.

## 7 Decommissioning

### 7.1 Temporarily decommissioning the product



**Caution.**  
**Risk of material damage due to frost.**

The frost protection and monitoring devices are only active while the unit is connected to the power mains and switched on via the on/off button, and when the gas isolator cock is open.

- ▶ Temporarily decommission the product only if no frost is expected.

- 
- ▶ Temporarily decommission the product only if no frost is expected.
  - ▶ Switch off the product via the main switch installed on-site.
    - ◀ The display goes out.
  - ▶ When decommissioning the product for a prolonged period (e.g. holiday), close the gas isolator cock and also, for combination products, the cold water stop valve.

### 7.2 Permanently decommissioning the product

- ▶ Have a competent person permanently decommission the product.

## 8 Recycling and disposal

- ▶ The competent person who installed your product is responsible for the disposal of the packaging.

## Guarantee and customer service 9



If the product is identified with this symbol:

- ▶ In this case, do not dispose of the product with the household waste.
- ▶ Instead, hand in the product to a collection centre for old electrical or electronic appliances.



If the product contains batteries that are marked with this symbol, these batteries may contain substances that are hazardous to human health and the environment.

- ▶ In this case, dispose of the batteries at a collection point for batteries.

## 9 Guarantee and customer service

### 9.1 Guarantee

For information on the manufacturer's guarantee, you can write to the contact address that is provided on the back page.

### 9.2 Customer service

To ensure regular servicing, it is strongly recommended that arrangements are made for a Maintenance Agreement. Please contact Vaillant Service Solutions for further details:

Telephone: 0330 100 3461

# Appendix

## Appendix

### A Status codes – Overview

Status codes that are not listed here can be viewed in the installation instructions.

Status code	Parameter	Meaning
Displays in heating mode		
<b>S.00</b>	<b>Heating: No heat demand</b>	Heating: No heat demand
<b>S.02</b>	<b>Heating mode: Pump pre-run</b>	Heating mode: Pump pre-run
<b>S.03</b>	<b>Heating mode: Ignition</b>	Heating mode: Ignition
<b>S.04</b>	<b>Heating mode: Burner on</b>	Heating mode: Burner on
<b>S.06</b>	<b>Heating mode: Fan overrun</b>	Heating mode: Fan overrun
<b>S.07</b>	<b>Heating mode: Pump overrun</b>	Heating mode: Pump overrun
<b>S.08</b>	<b>Heating mode: Anti-cycling time</b>	Heating, remaining anti-cycling time xx mins
Displays in hot water handling mode		
<b>S.10</b>	<b>DHW demand</b>	Hot water requirement via flow sensor
<b>S.14</b>	<b>DHW mode: Burner on</b>	DHW mode: Burner on
Displays in Comfort mode with warm start or hot water handling mode with cylinder		
<b>S.20</b>	<b>DHW demand</b>	Hot water requirement
<b>S.22</b>	<b>DHW mode: Pump pre-run</b>	DHW mode: Pump pre-run
<b>S.24</b>	<b>DHW mode: Burner on</b>	DHW mode: Burner on
Others		
<b>S.31</b>	<b>No heat demand: Summer mode</b>	Summer mode active
<b>S.34</b>	<b>Heating mode: Frost protection</b>	Frost protection mode, frost protection
<b>S.46</b>	<b>Waiting time: Measuring program</b>	Comfort protection mode, flame loss at minimum load

### B Troubleshooting

Fault	Cause	Measure
Product does not start up: – No hot water – Heating remains cold	The gas isolator cock installed on-site and/or the gas isolator cock on the product is closed.	Open both gas isolator cocks.
	The power supply in the building is disconnected.	Check the fuse in the building. The product switches on automatically when the power is restored.
	The product is switched off.	Switch on the product (→ "Switching on the product" section).
	The heating flow temperature is set too low or to the <b>Heating off</b> position, and/or the hot water temperature is set too low.	Set the heating flow temperature and hot water temperature (→ "Setting the heating flow temperature" section/→ "Setting the hot water temperature" section).



## Appendix

Fault	Cause	Measure
Product does not start up: – No hot water – Heating remains cold	The system pressure is insufficient. Low water pressure in the heating installation (fault message: <b>F.22</b> ).	Fill the heating installation (→ "Filling the heating installation" section).
	There is air in the heating installation.	Have your competent person purge the heating installation.
	After three unsuccessful attempts to ignite the flame, the product switches to fault mode (fault message: <b>F.28</b> ).	Press the fault clearance key for one second. The product makes another attempt to ignite the flame.  If you have been unable to eliminate the ignition fault after three fault clearance attempts, consult a competent person.







0020230534\_01 ■ 10.10.2016

**supplier**

**Vaillant Ltd.**

Nottingham Road ■ Belper ■ Derbyshire ■ DE56 1JT

Telephone 0330 100 3461

info@vaillant.co.uk ■ www.vaillant.co.uk

© These instructions, or parts thereof, are protected by copyright and may be reproduced or distributed only with the manufacturer's written consent.

We reserve the right to make technical changes.