

For the operator

Operating instructions



flexoTHERM exclusive

VWF 57 - 197/4, VWF 57 - 117/4 230V

GB, IE

Publisher/manufacture

Vaillant GmbH

Berghäuser Str. 40 ■ D-42859 Remscheid
Tel. +49 21 91 18-0 ■ Fax +49 21 91 18-2810
info@vaillant.de ■ www.vaillant.de



Contents

Contents

1	Safety	3	6.3	Reading maintenance messages	13
1.1	Action-related warnings	3	6.4	Checking the system pressure	13
1.2	Intended use	3	6.5	Checking the brine circuit's filling pressure.....	13
1.3	General safety information.....	4	7	Troubleshooting	13
2	Notes on the documentation	7	7.1	Fault message	13
2.1	Observing other applicable documents	7	8	Decommissioning	14
2.2	Storing documents.....	7	8.1	Switching off the heat pump	14
2.3	Applicability of the instructions.....	7	8.2	Permanently decommissioning the product.....	14
3	System overview	7	8.3	Recycling and disposal	14
3.1	Heat pump system design	7	9	Guarantee and customer service	15
4	Product description	8	9.1	Guarantee.....	15
4.1	Product design.....	8	9.2	Customer service.....	15
4.2	Serial number	8	Appendix	16	
4.3	Opening the front flap	8	A	Overview of the operator's operating level	16
4.4	Operator control panel.....	8			
4.5	CE label	9			
4.6	Safety devices	9			
5	Operating	10			
5.1	Basic display.....	10			
5.2	Operating concept	11			
5.3	Menu display.....	11			
5.4	Operating levels.....	11			
5.5	Starting up the product	12			
5.6	Adjusting the target cylinder temperature	12			
5.7	Yield indicator	12			
5.8	Displaying the Live Monitor.....	12			
5.9	Displaying the building circuit pressure	12			
5.10	Displaying the environment circuit pressure	12			
5.11	Reading the operating statistics	12			
5.12	Setting the language.....	12			
6	Maintenance and care	13			
6.1	Fulfilling requirements for the installation site	13			
6.2	Caring for the product.....	13			

1 Safety

1.1 Action-related warnings

Classification of action-related warnings

The action-related warnings are classified in accordance with the severity of the possible danger using the following warning signs and signal words:

Warning symbols and signal words



Danger!

Imminent danger to life or risk of severe personal injury



Danger!

Risk of death from electric shock



Warning.

Risk of minor personal injury



Caution.

Risk of material or environmental damage

1.2 Intended use

There is a risk of injury or death to the user or others, or of damage to the product and other property in the event of improper use or use for which it is not intended.

The system is intended exclusively for domestic use.

The system is intended as a heat generator with cooling function for closed heating installations and for hot water generation. Operation of the pump outside the application limits results in the heat pump being switched off by the internal control and safety devices.

Cooling mode with radiator heating systems is not permitted since radiators do not have an adequate heat transfer surface area.

Intended use includes the following:

- observance of the operating instructions included for the product and any other system components
- compliance with all inspection and maintenance conditions listed in the instructions.

This product can be used by children aged from 8 years and above and persons with reduced physical, sensory or mental capabilities or lack of experience and knowledge if they have been given supervision or instruction concerning use of the product in a safe way and understand the hazards involved. Children must not play with the product. Cleaning and

1 Safety

user maintenance work must not be carried out by children unless they are supervised.

Any other use that is not specified in these instructions, or use beyond that specified in this document shall be considered improper use. Any direct commercial or industrial use is also deemed to be improper.

Caution.

Improper use of any kind is prohibited.

1.3 General safety information

1.3.1 Danger caused by improper operation

Improper operation may present a danger to you and others, and cause material damage.

- ▶ Carefully read the enclosed instructions and all other applicable documents, particularly the "Safety" section and the warnings.
- ▶ Only carry out the activities for which instructions are provided in these operating instructions.

1.3.2 Risk of death due to explosive and flammable materials

- ▶ Do not use or store explosive or flammable materials (e.g.

petrol, paper, paint) in the installation room of the product.

1.3.3 Risk of death due to changes to the product or the product environment

- ▶ Never remove, bridge or block the safety devices.
- ▶ Do not tamper with any of the safety devices.
- ▶ Do not damage or remove any seals on components. Only authorised competent persons or customer services may modify sealed components.
- ▶ Do not make any changes to:
 - The product itself
 - The product environment
 - The brine fluid, air and electricity supply lines
 - The drain line and expansion relief valve for the heat source circuit
 - The constructional conditions that may affect the operational reliability of the product

1.3.4 Risk of injury due to chemical burns caused by brine fluid

The brine fluid ethylene glycol is harmful to health.

- ▶ Avoid contact with the skin and eyes.

- ▶ Always wear gloves and protective goggles.
- ▶ Do not inhale or swallow.
- ▶ Observe the safety data sheet that accompanies the brine fluid.
- ▶ Faults and damage should be immediately rectified by a competent person.
- ▶ Adhere to the maintenance intervals specified.

1.3.5 Preventing the risk of injury from freezing as a result of touching coolant

The product is supplied with an operational filling of R 410 A refrigerant. Escaping coolant may cause freezing if the exit point is touched.

- ▶ If coolant escapes, do not touch any components of the product.
- ▶ Do not inhale any vapours or gases that escape from the refrigerant circuit as a result of leaks.
- ▶ Avoid skin or eye contact with the coolant.
- ▶ In the event of skin or eye contact with the coolant, seek medical advice.

1.3.6 Risk of injury and material damage due to maintenance and repairs carried out incorrectly or not carried out at all

- ▶ Never attempt to carry out maintenance work or repairs on your product yourself.

1.3.7 Risk of material damage caused by frost

- ▶ Ensure that the heating installation always remains in operation during freezing conditions and that all rooms are sufficiently heated.
- ▶ If you cannot ensure the operation, have a competent person drain the heating installation.

1.3.8 Avoid environmental damage caused by escaping coolant

The product contains R 410 A refrigerant. The coolant must not be allowed to escape into the atmosphere. R410A is a fluorinated greenhouse gas covered by the Kyoto Protocol, with a GWP of 2088 (GWP = global warming potential). If this gas escapes into the atmosphere, its impact is 2088 times greater than the natural greenhouse gas CO₂.

Before the product is disposed of, the coolant that is contained in it must be completely drained into a suitable vessel so that



1 Safety

it can then be recycled or disposed of in accordance with regulations.

- ▶ Ensure that only officially certified competent persons with appropriate protective equipment carry out maintenance work on the refrigerant circuit or access it.
- ▶ Arrange for the refrigerant that is contained in the product to be recycled or disposed of by a certified competent person in accordance with the regulations.



2 Notes on the documentation

2.1 Observing other applicable documents

- ▶ You must observe all operating instructions enclosed with the system components.

2.2 Storing documents

- ▶ Keep this manual and all other applicable documents safe for future use.

2.3 Applicability of the instructions

These instructions apply only to:

Applicability: Great Britain
OR Ireland

Product

VWF 57/4

VWF 87/4

VWF 117/4

VWF 157/4

VWF 197/4

Applicability: Great Britain
OR Ireland

Product

VWF 57/4 230 V

VWF 87/4 230 V

VWF 117/4 230 V

3 System overview

3.1 Heat pump system design

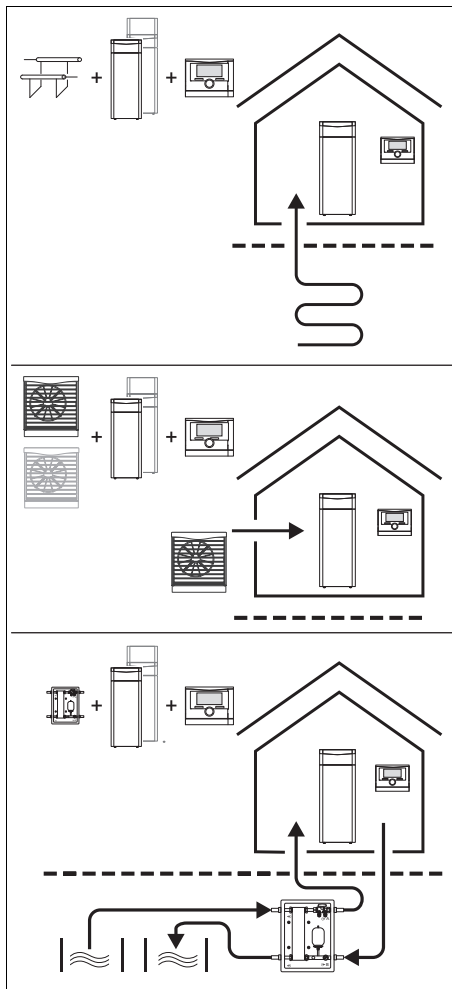

The heat pump system consists of the following components:

- Heat pump
- System controller (from VRC 700)
- Outside temperature sensor with DCF receiver
- System sensor, if required
- With ground heat source: Ground sensor

4 Product description

- For the air heat source (only products with 400 V): Air/brine collector(s)
- With well water heat source: Groundwater module

There is an opportunity for active cooling to take place via circulation reversal for the heat sources air, ground and groundwater.

4 Product description

4.1 Product design

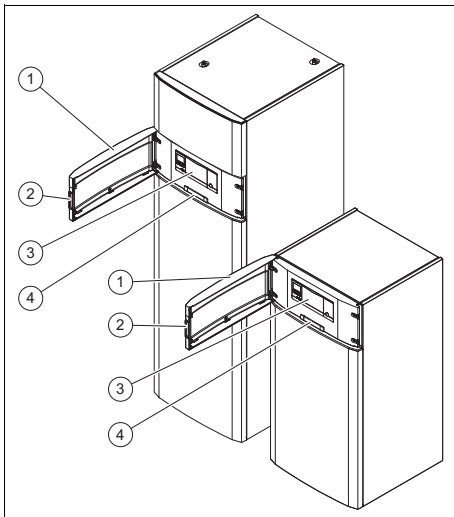

- | | |
|-------------------|-----------------------------------|
| 1 Front flap | 3 Control elements |
| 2 Recessed handle | 4 Plate showing the serial number |

4.2 Serial number





The serial number is located on a plate behind the front flap. The 7th to 16th digits of the serial number form the article number.

4.3 Opening the front flap

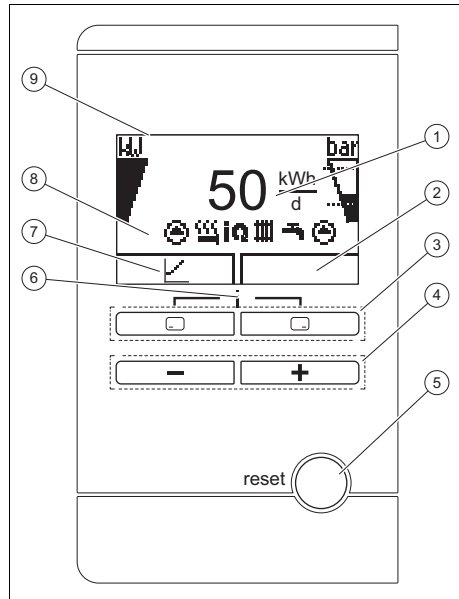
1. Take hold of the recessed handle in the front flap on the left- or right-hand side.
2. Pull the recessed handle.

4.4 Operator control panel



- | | |
|--|--|
| 1 Displays the daily environmental energy yield | 5 Reset button |
| 2 Display of the current assignment of the right-hand selection button | 6 Access to the menu for additional information |
| 3 Left- and right-hand selection buttons   | 7 Display of the current configuration of the left-hand selection button |
| 4  and  button | 8 Displays the symbols for the current operating status of the heat pump |
| | 9 Display |

4.5 CE label



The CE label shows that the products comply with the basic requirements of the applicable directives as stated on the identification plate.

The declaration of conformity can be viewed at the manufacturer's site.

4.6 Safety devices

4.6.1 Frost protection function

The frost protection function for the system is controlled via the system controller. If the system controller fails, the heat pump guarantees limited frost protection for the heating circuit.

4.6.2 Protection against low heating water pressure

This function continuously monitors the pressure of the heating water in order to prevent a possible loss of heating water.

4.6.3 Brine loss protection system

The brine loss protection system continuously monitors the fluid pressure in the environment circuit in order to prevent a possible shortage of fluid.

4.6.4 Freeze protection

This function prevents the evaporator from freezing when the heat source temperature drops below a certain value.

The outlet temperature of the heat source is constantly measured. If the outlet temperature of the heat source falls below a certain value, the compressor temporarily switches off and displays a status message. If this fault occurs three times in a row, it is switched off and a fault message is displayed.

4.6.5 Pump- and valve-blocking protection system

This function prevents the pumps for heating water and brine and all diverter valves from sticking. The pumps and the valves, which were out of operation for 23 hours, are switched on for 10 - 20 seconds, one after the other.

4.6.6 High-pressure pressure switch in the refrigeration circuit

The high-pressure pressure switch shuts down the heat pump if the pressure in the coolant circuit is too high. If the pressure in the heat pump's refrigeration circuit exceeds the maximum pressure, the high-pressure pressure switch temporarily shuts down the heat pump. Following a waiting period, another attempt is made to start the heat pump. After three failed start attempts in succession, a fault message is displayed.

- Refrigeration circuit pressure max.: 4.60 MPa (g) (46.00 bar (g))
- Waiting period: 5 minutes (after the first occurrence)
- Waiting period: 30 minutes (after the second and every further occurrence)

The fault counter is reset if both of the following conditions are met:

- Heat requirement without switching off prematurely
- 60 minutes of uninterrupted operation

4.6.7 Hot gas thermostat in the refrigeration circuit

The hot gas thermostat shuts down the heat pump if the temperature in the refrigeration circuit is too high. If the temperature in the heat pump's refrigeration circuit exceeds the maximum temperature, the hot gas thermostat temporarily shuts down the heat pump. Following a waiting period, another attempt is made to start the heat

5 Operating

pump. After three failed start attempts in succession, a fault message is displayed.

- Max. refrigeration circuit temperature: 135 °C
- Waiting period: 5 minutes (after the first occurrence)
- Waiting period: 30 minutes (after the second and every further occurrence)

The fault counter is reset if both of the following conditions are met:

- Heat requirement without switching off prematurely
- 60 minutes of uninterrupted operation

4.6.8 Safety cut-out (SCO) in the heating circuit

If the temperature in the heating circuit of the internal auxiliary electric heating exceeds the maximum temperature, the SCO shuts down the auxiliary electric heating as a securing measure. Following a waiting period, another attempt is made to start the auxiliary electric heating. A fault message is displayed that can only be reset by pressing the Reset button or by switching the heat pump off and on again.



- Max. heating circuit temperature: 85 °C

5 Operating

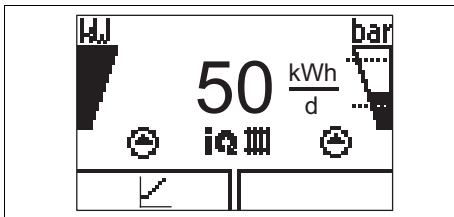
5.1 Basic display



Symbol	Meaning	Explanation
	Compressor	<ul style="list-style-type: none"> – Filled: Compressor in operation – Not filled: Compressor not in operation
	Current filling pressure of the heating system The dashed lines show the permitted range.	<ul style="list-style-type: none"> – Permanently on: Filling pressure in the permitted range. – Flashing: Filling pressure outside the permitted range.
	Pumps	<ul style="list-style-type: none"> – Left continuously on: Brine pump in operation – Right continuously on: Heating pump in operation
	Auxiliary electric heating	<ul style="list-style-type: none"> – Flashing: Auxiliary electric heating in operation – + : Auxiliary electric heating active for heating mode – + : Auxiliary electric heating active for hot water handling mode
	Green iQ mode	<ul style="list-style-type: none"> – Product equipped with energy-saving technology
	Heating mode	<ul style="list-style-type: none"> – Continuously on: Heating mode active

Symbol	Meaning	Explanation
	Cooling mode	– Continuously on: Cooling mode active (active or passive)
	Hot water generation	– Continuously on: Hot water handling mode active
	Fault in the product	– Appears instead of the basic display, may be an explanatory plain text display



The basic display shows you the product's operating mode. If you press a selection button, the activated function is displayed in the display.





You can switch back to the basic display by:



- Pressing  to exit the selection levels
- Not pressing any button for longer than 15 minutes.

If there is a fault message present, the basic display switches to the fault message.

5.2 Operating concept

Operator control element	Function
	<ul style="list-style-type: none"> – Displaying the environmental energy yield in heating mode, hot water handling mode and cooling mode – Cancelling a change to a set value – Going one selection level higher
	<ul style="list-style-type: none"> – Confirm setting – Going one selection level lower

Operator control element	Function
 + 	– Calling up the menu
 or 	<ul style="list-style-type: none"> – Reducing or increasing the set value – Scrolling through menu entries

The current function of the  and  selection buttons is shown on the display.

Adjustable values are always displayed as flashing.

You must always confirm a change to a value. Only then is the new setting saved. You can press  to cancel a procedure at any time.

5.3 Menu display

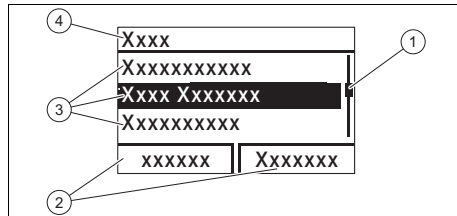

- | | |
|---|--------------------------------|
| 1 Scroll bar | 3 Selection level list entries |
| 2 Current assignment of the selection buttons | 4 Selection level buttons |

You can find an overview of the menu structure in the appendix.

5.4 Operating levels

The product has two operating levels.

The operating level for the operator shows the information and offers set-up options that do not require any special prior knowledge.

The operating level for the competent person is protected by a code.

Overview of the operator's operating level (→ Page 16)

5 Operating

5.5 Starting up the product

- ▶ Only start up the product once the casing has been completely closed.

5.6 Adjusting the target cylinder temperature

In order to achieve energy-efficient hot water generation predominantly from the energy extracted from the environment, the factory setting for the desired hot water temperature must be adjusted on the system controller.

- ▶ To do this, adjust the cylinder set target temperatures (**Desired DHW circuit temperature**) to between 50 and 55 °C, for example.
 - ◁ Depending on the source of energy obtained from the environment, hot water output temperatures of between 55 and 62 °C are reached.

5.7 Yield indicator

Displays the environmental energy yield as a cumulative value for a period of a day, a month and the total for the heating, hot water generation and cooling modes.

Displays the working figure for a period of a month and the total for the heating and hot water generation modes. The working figure is the ratio of thermal energy generated to the operating current used. Monthly values may vary considerably since, for example, in the summer only hot water generation is used. A large number of factors influence this estimate, e.g. the type of heating installation (direct heating mode = low flow temperature or indirect heating mode via buffer cylinder = high flow temperature). This figure may therefore deviate by up to 20%.

The working figures only record the power consumption of internal components, not of external components such as external heating circuit pumps, valves, etc.

5.8 Displaying the Live Monitor

Menu → Live Monitor

- You can use the Live Monitor to display the current status of the product.

5.9 Displaying the building circuit pressure

Menu → Live Monitor → Building circuit pressure

- Current filling pressure of the heating system

5.10 Displaying the environment circuit pressure

Menu → Live Monitor → Environment circuit pressure

- Current filling pressure in the environment circuit

5.11 Reading the operating statistics

Menu → Information → Heating op. hours

Menu → Information → DHW operating hours

Menu → Information → Cooling op. hours

Menu → Information → Total operating hours

Operating hours for heating mode, hot water handling mode, cooling mode and the overall operation

5.12 Setting the language

Menu → Basic settings → Language

- Setting the desired language

6 Maintenance and care

6.1 Fulfilling requirements for the installation site

The installation site must be dry and frost-proof throughout.

Conditions: Outdoor air heat source

The air/brine collector is designed to be operated with outdoor air. The air intake and blow-off route of the outdoor unit must be kept clear at all times in order to guarantee that the air can flow unhindered and as intended. Vegetation and, in winter, snowfall, must be cleared.

You are not permitted to make any subsequent structural alterations which may result in a reduced room volume or a change to the temperature at the installation site.

6.2 Caring for the product



Caution.
Risk of material damage caused by unsuitable cleaning agents.

- ▶ Do not use sprays, scouring agents, detergents, solvents or cleaning agents that contain chlorine.

- ▶ Clean the casing with a damp cloth and a little solvent-free soap.

6.3 Reading maintenance messages

If the  symbol is shown in the display, the product requires maintenance work. The product is not in fault mode; it continues to operate.

- ▶ Consult a competent person.

6.4 Checking the system pressure

- ▶ Check the filling pressure of the heating installation every day for a week after initial start-up and maintenance work, and then twice a year.
 - Filling pressure: ≥ 0.07 MPa (≥ 0.70 bar)
- Filling pressure too low
 - ▶ Inform your competent person so that he can add heating water and increase the filling pressure.

6.5 Checking the brine circuit's filling pressure

- ▶ Check the brine circuit's filling pressure at regular intervals. Read the brine circuit's filling pressure in the heat pump's display.
 - Brine fluid operating pressure range: 0.07 ... 0.20 MPa (0.70 ... 2.00 bar)

7 Troubleshooting

7.1 Fault message



Note

If the heat pump has switched off automatically due to a fault, the system controller can be used to activate a limp home mode with the electric auxiliary heating.

If several faults occur at the same time, the display shows the corresponding fault messages for two seconds each in alternation.

F.714 Environment circuit: Pressure too low

If the filling pressure falls below the minimum pressure, the heat pump will be switched off automatically.

- Minimum brine fluid pressure: ≥ 0.05 MPa (≥ 0.50 bar)
- Min. brine fluid operating pressure: ≥ 0.07 MPa (≥ 0.70 bar)

8 Decommissioning

- ▶ Inform your competent person so that he can top up the brine fluid.

F.723 Building circuit: Pressure too low

If the filling pressure falls below the minimum pressure, the heat pump will be switched off automatically.

- Min. heating circuit pressure:
≥ 0.05 MPa (≥ 0.50 bar)
- Min. heating circuit operating pressure:
≥ 0.07 MPa (≥ 0.70 bar)

- ▶ Inform your competent person so that he can top up the heating water.

F.1120 Heating rod: Phase failure

The product has an internal circuit breaker which switches off the heat pump in the event of short circuits or the failure of one (product with 230 V power supply) or several (product with 400 V power supply) current-carrying phases. This may be caused by a defect in the internal auxiliary electric heater, for example.

If the auxiliary electric heater is defective, the Anti-legionella function is not guaranteed.

- ▶ Inform your competent person so that they can rectify the fault and reset the internal circuit breaker.

8 Decommissioning

8.1 Switching off the heat pump

8.1.1 Temporarily decommissioning the product

- ▶ Use the partition that is installed on-site (e.g. fuses or power switches) to disconnect the product from the power supply.

8.1.2 Protecting the product against frost

- ▶ Observe the installation site requirements for the product. (→ Page 13)

8.2 Permanently decommissioning the product

1. Have a competent person permanently decommission the product.
2. Have the product disposed of by a competent person.

8.3 Recycling and disposal

- ▶ The competent person who installed your product is responsible for the disposal of the packaging.



If the product is identified with this symbol:

- ▶ In this case, do not dispose of the product with the household waste.
- ▶ Instead, hand in the product to a collection centre for old electrical or electronic appliances.



If the product contains batteries that are marked with this symbol, these batteries may contain substances that are hazardous to human health and the environment.

- ▶ In this case, dispose of the batteries at a collection point for batteries.

8.3.1 Arranging disposal of the brine fluid

The product is filled with the brine fluid ethylene glycol, although when using ground as the heat source, aqueous solutions of propylene glycol may also be used as an alternative. Ethylene glycol is harmful to health.

- ▶ Brine fluid must only be disposed of by a qualified competent person.

8.3.2 Arranging disposal of coolant

The product is filled with R 410 A refrigerant.

The coolant must not be allowed to escape into the atmosphere.

Guarantee and customer service 9

- ▶ Coolant must only be disposed of by a qualified competent person.

9 Guarantee and customer service

9.1 Guarantee

Applicability: Great Britain

Vaillant provides a full parts and labour guarantee for this appliance for the duration as shown on the enclosed registration card which must be fully completed and returned within 30 days of installation. All appliances must be installed by a suitably competent person fully conversant and in accordance with all current regulations applicable to the appliance type installation. In the case of gas appliances the Gas Safety (Installation and Use) Regulations 1998, and the manufacturer's instructions. In the UK competent persons approved at the time by the Health and Safety Executive undertake the work in compliance with safe and satisfactory standards. Installers should also be fully conversant with and competent with all necessary electrical and building regulations that may apply to the installation.

In addition all unvented domestic hot water cylinders must be installed by a competent person to the prevailing building regulations at the time of installation (G3). All appliances shall be fully commissioned in accordance with our installation manual and Benchmark commissioning check list (this will be included within the installation manual). These must be signed and given to the user for safe keeping during the hand over process. Installers should also at this time advise the user of the annual servicing requirements and advise of appropriate service agreement.

Terms and conditions do apply to the guarantee, details of which can be found on the registration card included with this appli-

ance. In order to qualify for guarantee after one year the appliance must be serviced in accordance with our installation manual servicing instructions. The benchmark service history should be completed. Note - all costs associated with this service are excluded from this guarantee.

Failure to install and commission this appliance in compliance with the manufacturer's instructions will invalidate the guarantee (this does not affect the customer's statutory rights).

9.2 Customer service

Applicability: Great Britain

To ensure regular servicing, it is strongly recommended that arrangements are made for a Maintenance Agreement. Please contact Vaillant Service Solutions for further details:

Telephone: 0330 100 3461

Appendix

Appendix

A Overview of the operator's operating level

Setting level	Values		Unit	Increment, select	Default setting	Setting
	Min.	Max.				
Yield indicator →						
Energy yield: Day, Heating	Cumulative value		kWh			
Energy yield: Day, Domestic hot water	Cumulative value		kWh			
Energy yield: Day, Cooling	Cumulative value		kWh			
Energy yield: Month, Heating	Cumulative value		kWh			
Working figure: Month, Heating	Cumulative value					
Energy yield: Total, Heating	Cumulative value		kWh			
Working figure: Total, Heating	Cumulative value					
Energy yield: Month, Domestic hot water	Cumulative value		kWh			
Working figure: Month, Domestic hot water	Cumulative value					
Energy yield: Total, Domestic hot water	Cumulative value		kWh			
Working figure: Total, Domestic hot water	Cumulative value					
Live Monitor →						
Current status message(s)	Current value					
Building circuit pressure	Current value		bar			
Environment circuit pressure	Current value		bar			
Switch-on delay	Current value		min			
Flow temp. setpoint	Current value		°C			
Current flow temp.	Current value		°C			
Energy integral	Current value		°min			
Environment circuit inlet temperature	Current value		°C			
Environment circuit outlet temperature	Current value		°C			
Cooling capacity	Current value		kW			

Appendix

Setting level	Values		Unit	Increment, select	Default setting	Setting
	Min.	Max.				
Electrical power consumption	Current value		kW	Total power consumption of the heat pump without any external components connected (as-delivered condition).		
Heating rod power	Current value		kW			
Information →						
Contact data	Phone number					
Serial number	Permanent value					
Operating hours total	Cumulative value		h			
Hours heating	Cumulative value		h			
DHW operating hours	Cumulative value		h			
Cooling op. hours	Cumulative value		h			
Basic settings →						
Language	Current language			Languages available for selection	02 English	
Display contrast	Current value			1	25	
	15	40				
Resets →						
Reset anti-cycl. time	-			Cancel reset anti-cycl. time?	Yes/No	



0020213396_02 ■ 29.04.2016

Vaillant Ltd.

Nottingham Road ■ Belper ■ Derbyshire ■ DE56 1JT

Telephone 0330 100 3461

info@vaillant.co.uk ■ www.vaillant.co.uk

© These instructions, or parts thereof, are protected by copyright and may be reproduced or distributed only with the manufacturer's written consent.

We reserve the right to make technical changes.