

Operating instructions



ecoTEC sustain

24, 28, 34

GB

Publisher/manufacture

Vaillant GmbH

Berghauser Str. 40 ■ D-42859 Remscheid
Tel. +49 21 91 18-0 ■ Fax +49 21 91 18-2810
info@vaillant.de ■ www.vaillant.de



Contents

Contents	6	Care and maintenance	14
1 Safety	3	6.1 Maintenance	14
1.1 Action-related warnings	3	6.2 Caring for the product	14
1.2 Intended use	3	6.3 Reading maintenance messages	15
1.3 General safety information	4	6.4 Checking the condensate drain pipework and tundish	15
2 Notes on the documentation	7	7 Decommissioning	15
2.1 Observing other applicable documents	7	7.1 Temporarily decommissioning the product	15
2.2 Storing documents	7	7.2 Permanently decommissioning the product	15
2.3 Validity of the instructions	7	8 Recycling and disposal	15
3 Product description	7	9 Guarantee and customer service	16
3.1 Product design	7	9.1 Guarantee	16
3.2 Control elements	7	9.2 Customer service	16
3.3 Description of the display	8	Appendix	17
3.4 Information on the identification plate	8	A Operator level – overview	17
3.5 Serial number	9	B Status codes – Overview	17
3.6 CE label	9	C Troubleshooting and fault elimination	18
3.7 Energy Saving Trust Endorsed Products	9	C.1 Troubleshooting	18
4 Function	10	C.2 Rectifying faults	18
4.1 Operating concept	10		
4.2 Opening the isolator devices	11		
4.3 Switching on the product	11		
4.4 Setting the heating flow temperature	11		
4.5 Setting the hot water temperature	11		
4.6 Switching off the product's functions	12		
4.7 Guaranteeing the correct filling pressure in the heating circuit	12		
4.8 Switching the product to standby mode	13		
4.9 Protecting the heating installation against frost	14		
5 Troubleshooting	14		
5.1 Detecting and rectifying faults	14		
5.2 Displaying the status codes	14		

1 Safety

1.1 Action-related warnings

Classification of action-related warnings

The action-related warnings are classified in accordance with the severity of the possible danger using the following warning signs and signal words:

Warning symbols and signal words



Danger!

Imminent danger to life or risk of severe personal injury



Danger!

Risk of death from electric shock



Warning.

Risk of minor personal injury



Caution.

Risk of material or environmental damage

1.2 Intended use

There is a risk of injury or death to the user or others, or of damage to the product and other property in the event of improper use or use for which it is not intended.

The product is intended as a heat generator for closed heat-

ing installations and for hot water generation.

Intended use includes the following:

- observance of the operating instructions included for the product and any other system components
- compliance with all inspection and maintenance conditions listed in the instructions.

This product can be used by children aged from 8 years and above and persons with reduced physical, sensory or mental capabilities or lack of experience and knowledge if they have been given supervision or instruction concerning use of the product in a safe way and understand the hazards involved. Children must not play with the product. Cleaning and user maintenance work must not be carried out by children unless they are supervised.

Any other use that is not specified in these instructions, or use beyond that specified in this document shall be considered improper use. Any direct commercial or industrial use is also deemed to be improper.

Caution.

Improper use of any kind is prohibited.

1 Safety

1.3 General safety information

1.3.1 Danger caused by improper operation

Improper operation may present a danger to you and others, and cause material damage.

- ▶ Carefully read the enclosed instructions and all other applicable documents, particularly the "Safety" section and the warnings.
- ▶ Only carry out the activities for which instructions are provided in these operating instructions.

1.3.2 Risk of death from escaping gas

What to do if you smell gas in the building:

- ▶ Avoid rooms that smell of gas.
- ▶ If possible, open doors and windows fully and ensure adequate ventilation.
- ▶ Do not use naked flames (e.g. lighters, matches).
- ▶ Do not smoke.
- ▶ Do not use any electrical switches, mains plugs, door-bells, telephones or other communication systems in the building.

- ▶ If it is safe to do so, close the emergency control valve or the main isolator.
- ▶ If possible, close the gas isolator cock on the product.
- ▶ Warn other occupants in the building by yelling or banging on doors or walls.
- ▶ Leave the building immediately and ensure that others do not enter the building.
- ▶ Notify the gas supply company or the National Grid +44 (0) 800 111999 by telephone once you are outside of the building.

1.3.3 Risk of death due to a blocked or leaking flue gas pipe

What to do if you smell flue gas in the property:

- ▶ Open all accessible doors and windows fully to provide ventilation.
- ▶ Switch off the product.
- ▶ Inform a competent person.

1.3.4 Risk of death due to explosive and flammable materials

- ▶ Do not use or store explosive or flammable materials (e.g. petrol, paper, paint) in the installation room of the product.



1.3.5 Risk of death due to changes to the product or the product environment

- ▶ Never remove, bridge or block the safety devices.
- ▶ Do not tamper with any of the safety devices.
- ▶ Do not damage or remove any seals on components.
- ▶ Do not make any changes:
 - The product itself
 - to the gas, air, water and electricity supplies
 - to the entire flue gas installation
 - to the entire condensate drain system
 - to the expansion relief valve
 - to the drain pipework
 - to constructional conditions that may affect the operational reliability of the product

1.3.6 Risk of poisoning caused by insufficient supply of combustion air

Conditions: Open-flued operation

- ▶ Ensure that there is a sufficient supply of combustion air.



1.3.7 Risk of corrosion damage due to unsuitable combustion and room air

Sprays, solvents, chlorinated cleaning agents, paint, adhesives, ammonia compounds, dust or similar substances may lead to corrosion on the product and in the air/flue pipe.

- ▶ Ensure that the supply of combustion air is always free of fluorine, chlorine, sulphur, dust, etc.
- ▶ Ensure that no chemical substances are stored at the installation site.

1.3.8 Risk of material damage caused by frost

- ▶ Ensure that the heating installation always remains in operation during freezing conditions and that all rooms are sufficiently heated.
- ▶ If you cannot ensure the operation, have a competent person drain the heating installation.



1 Safety

1.3.9 Risk of injury and material damage due to maintenance and repairs carried out incorrectly or not carried out at all

- ▶ Never attempt to carry out maintenance work or repairs on your product yourself.
- ▶ Faults and damage should be immediately rectified by a competent person.
- ▶ Adhere to the maintenance intervals specified.



Notes on the documentation 2

2 Notes on the documentation

2.1 Observing other applicable documents

- ▶ You must observe all operating instructions enclosed with the system components.

2.2 Storing documents

- ▶ Keep this manual and all other applicable documents safe for future use.

2.3 Validity of the instructions

These instructions apply only to:

Product article number

ecoTEC sustain 24	VUW 246/7-2 (H-GB)	0010019980
ecoTEC sustain 28	VUW 286/7-2 (H-GB)	0010019981
ecoTEC sustain 34	VUW 346/7-2 (H-GB)	0010019982

Gas Council Numbers

ecoTEC sustain 24	VUW 246/7-2 (H-GB)	47-044-79
ecoTEC sustain 28	VUW 286/7-2 (H-GB)	47-044-80
ecoTEC sustain 34	VUW 346/7-2 (H-GB)	47-044-81

3 Product description

3.1 Product design

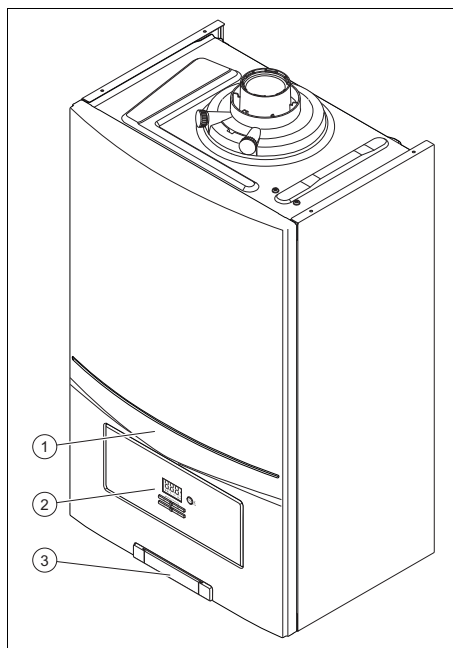

- 1 Product
- 2 Control elements
- 3 Plate with serial number on the rear

3.2 Control elements

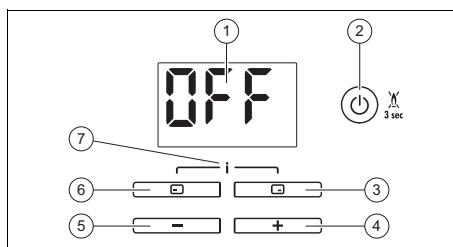

- 1 Display
- 2 On/off button and reset button
- 3 Right selection button
- 4 \oplus button
- 5 \ominus button
- 6 Left selection button
- 7 Access to the menu for additional information/installer level

3 Product description

3.3 Description of the display

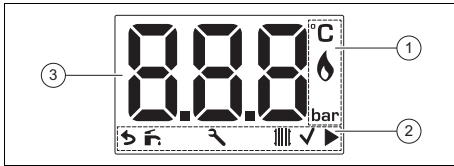

- | | |
|---|---|
| <p>1 Operating information</p> <p>2 Operating mode, selecting and confirming the operating mode</p> | <p>3 Display showing the current heating flow temperature, the filling pressure in the heating installation, the operating mode or a fault code</p> |
|---|---|

Symbol	Meaning
	Burner operating correctly – Burner on
	Heating installation filling pressure – Permanently on: Filling pressure in the permitted range – Flashing: Filling pressure outside the permitted range, purging function activated
	DHW mode – Permanently on: Hot water activated – Flashing: Burner on in draw-off mode
	Heating mode – Permanently on: Heating mode activated – Flashing: Burner on in heating mode
	Maintenance required Information on maintenance messages in the event of faults
	Setting to be confirmed
	Navigating through various menus

Symbol	Meaning
F.XX / Err / Ser	Fault in the product – Appears instead of the basic display.
S.XX	Status code
OFF	– Heating mode is switched off (summer mode) – Hot water handling mode is switched off (product with integrated hot water generation) – Appears when the product goes into standby mode.



3.4 Information on the identification plate

The identification plate is mounted on the underside of the product in the factory.

The identification plate keeps record of the country in which the product is to be installed.

Information on the identification plate	Meaning
Condensing technology	Efficiency class of the boiler in accordance with EC Directive 92/42/EEC
Serial number	For quality control purposes; 3rd and 4th digits = year of production For quality control purposes; 5th and 6th digits = week of production For identification purposes; 7th to 16th digits = product article number For quality control purposes; 17th to 20th digits = place of manufacture
... ecoTEC ...	Product designation
Cat.	Approved gas category
Type: Xx3(x)	Permissible flue gas connections
2H / 2E / 3P / 2K...	Gas group and gas connection pressure as set at the factory

Product description 3

Information on the identification plate	Meaning
Tmax	Max. flow temperature
PMS	Maximum water pressure in heating mode
NOx	NOx class for the product
V Hz	Electric connection
W	Max. electrical power consumption
IP	Protection class
Code (DSN)	Specific product code
	Heating mode
Qn	Nominal heating load range in heating mode
Pn	Nominal heat output range in heating mode
Pnc	Nominal heat output range in heating mode (condensing technology)
	Hot water generation
Qnw	Nominal heating load range in hot water handling mode
Pnw	Nominal heat output range in hot water handling mode
D	Specific flow rate
PMW	Maximum water pressure in hot water handling mode
	Barcode with serial number
GC No.	Gas council number



Note

Make absolutely sure that the product is compatible with the gas group at the installation site.

3.5 Serial number

The serial number can be found on the rear of a plastic plate at the bottom of the front casing and on the identification plate.

3.6 CE label



The CE label shows that the products comply with the basic requirements of the applicable directives as stated on the identification plate.

The declaration of conformity can be viewed at the manufacturer's site.

3.7 Energy Saving Trust Endorsed Products



Only the most energy efficient products can carry the 'Energy Saving Trust Endorsed Product' landmark making it easy for consumers to choose products that have met strict energy performance criteria.

Available for: Boilers, Heating controls and chemical inhibitors, the Energy Saving Trust endorsed product landmark gives consumers confidence that a product will cost less to run, help lower energy bills and reduce carbon emissions.

About the Energy Saving Trust

Energy Saving Trust is an independent and impartial organisation that provides trusted energy saving advice to empower millions of people to lead affordable, low energy lifestyles. For more information visit energysavingtrust.org.uk





4 Function



4 Function

4.1 Operating concept

The display switches on when you switch on the product or press a button. You can now configure settings by pressing the buttons again.

When you switch the product off using the on/off button, the display goes out (the frost protection function is active for as long as power is supplied).

Button	Meaning
	<ul style="list-style-type: none">– Setting the hot water temperature– Cancelling the change to a set value or activating an operating mode– Calling up a higher selection level in the menu
	<ul style="list-style-type: none">– Setting the heating flow temperature, filling pressure of the heating system or activating the heating mode– Confirming a set value or activating an operating mode– Calling up a lower selection level in the menu– Read the system pressure (press twice)
	<ul style="list-style-type: none">– Calling up the additional functions
	<ul style="list-style-type: none">– Navigating between individual menu items– Increasing or decreasing the chosen set value
	<ul style="list-style-type: none">– On/off button (press and hold the button for < 3 s)– Reset button (press and hold the button for > 3 s)

Both selection buttons have a soft key function, i.e. their function can change. If, for example, you press the left-hand selection button  in the basic display, the current function switches from  (Domestic hot water temperature) to  (Back).

Adjustable values are always displayed as flashing.

You must always confirm a change to a value. Only then is the new setting saved. You can press  to cancel a procedure at any time. If you do not press any buttons for longer 15 minutes, the display returns to the basic display.

4.1.1 Basic display



The basic display shows the current product status.

To return to the basic display, press the  button. If you do not press any buttons within three minutes, the display becomes dark and automatically switches back to the basic display.

If an error message appears, the error code will be shown on the basic display.

The available functions vary depending on whether:

- A room thermostat is connected to the product or not
- A domestic hot water cylinder with temperature sensor is connected to the product or not

4.1.2 Operating levels

The product has two operating levels:

- The operator level shows the most important information and offers set-up options which do not require any special prior knowledge.
- Specialised knowledge is required in order to use the installer level (access for competent persons). This is therefore protected by an access code.

4.2 Opening the isolator devices

1. Ask the competent person who installed the product to explain to you where these isolator devices are located and how to handle them.
2. Open the gas isolator cock installed on-site.
3. Open the gas isolator cock, which is directly below the product or in its immediate vicinity.
4. Open the service valves in the heating installation's flow and return.
5. Open the cold water stop valve.

4.3 Switching on the product

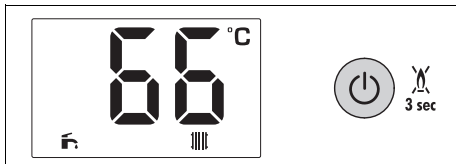

1. Only start up the product once the casing has been completely closed.
2. If the display is switched off, press  for less than 3 seconds.
 - ◁ The basic display is shown in the display.

4.4 Setting the heating flow temperature





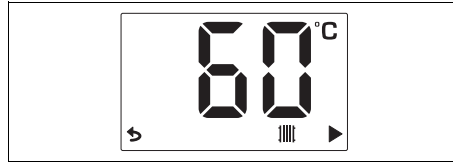

Note

If the eBUS room temperature control is connected to the product, the domestic hot water temperature and the heating flow temperature cannot be set via the operating display.

Conditions: The temperature is controlled by the product



- ▶ Press .
 - ◁ The heating flow temperature flashes in the display.
- ▶ Press the  or  button to set the temperature.
 - ◁ ✓ is shown in the display.
- ▶ Confirm by pressing .



Note

If you press the  button again, the heating installation pressure is shown in the display.

- ▶ Press .
 - ◁ The basic display is shown.

Conditions: Controller-regulated temperature

- ▶ You cannot set the heating flow temperature.



Note

If you press the  button, the heating installation pressure is shown in the display.

4.5 Setting the hot water temperature







Note

If the eBUS room temperature control is connected to the product, the domestic hot water temperature and the heating flow temperature cannot be set via the operating display.

4 Function

Conditions: The temperature is controlled by the product



- ▶ Press 
 - ◁ The domestic hot water temperature now flashes in the display.
- ▶ Press the  or  button to set the temperature.
 - ◁ ✓ is shown in the display.
- ▶ Press the  button to confirm.
- ▶ Press 
 - ◁ The display switches to the basic display.





Conditions: Controller-regulated temperature

- ▶ Set the hot water temperature on the controller. See the instructions for the controller.

4.6 Switching off the product's functions

4.6.1 Switching off heating mode (Summer mode)

Conditions: The temperature is controlled by the product





- ▶ Press 
 - ◁ The heating flow temperature flashes in the display.
- ▶ Press  and press and hold  until OFF is shown in the display.
 - ◁ ✓ is shown in the display.
- ▶ Confirm by pressing 
 - ◁ Heating mode is switched off.
- ▶ Press 
 - ◁ The display switches to the basic display.

Conditions: Controller-regulated temperature

- ▶ You cannot switch off heating mode on the product. See the instructions for the controller.

4.6.2 Switching off the hot water handling mode

Conditions: Temperature regulated by the product or by the room temperature controller

- ▶ Press 
 - ◁ The domestic hot water temperature now flashes in the display.
- ▶ Press  and press and hold  until OFF is shown in the display.
 - ◁ ✓ is shown in the display.
- ▶ Press  to confirm.
 - ◁ Hot water generation is switched off.
- ▶ Press 
 - ◁ The display switches to the basic display.

4.7 Guaranteeing the correct filling pressure in the heating circuit

4.7.1 Checking the system pressure



Note

Your product has a pressure sensor and a digital pressure indicator.

The product switches to fault mode if the pressure falls below the required system pressure (below 0.05 MPa (0.5 bar)). If the heating installation extends over several floors, a higher system pressure may be necessary. Ask your competent person for details.

1. Press  twice.
 - ◁ The current system pressure is shown in the display.

2. Check the system pressure on the display.

1 / 2

System pressure: 0.08 ... 0.2 MPa
(0.80 ... 2.0 bar)

The system pressure is in the intended pressure range.

2 / 2

System pressure: < 0.08 MPa
(< 0.80 bar)

- ▶ Fill the heating installation.
(→ Page 13)
 - ◁ When you have reached a sufficient pressure range, the display disappears after 20 seconds.

4.7.2 Filling the heating installation



Caution.

Risk of material damage due to heating water that is extremely calciferous or corrosive or contaminated by chemicals.

Unsuitable tap water damages the seals and diaphragms, blocks components in the product and heating installation through which the water flows and causes noise.

- ▶ Only fill the heating installation with suitable heating water.
- ▶ In case of doubt, ask a competent person for details.



Note

The competent person is responsible for filling the heating installation the first time.

1. On-site, connect the filling cock to a cold water pipe, as explained by the competent person.
2. Open all radiator valves (thermostatic radiator valves) of the heating installation.
3. Open the cold water pipe.
4. Turn the filling cock on slowly and allow water to flow in until the required system pressure has been reached.
5. Close the cold water pipe.
6. Purge all radiators.
7. Check the system pressure on the display. (→ Page 12)
8. Top up with more water if required.
9. Close the filling cock.
10. Disconnect the filling cock from the cold water pipe.

4.8 Switching the product to standby mode

- ▶ Press the  button for less than three seconds.
 - ◁ Once the requirement currently in use has finished, the display will show OFF and go out.
 - ◁ The product is now in standby mode.
 - ◁ The product's frost protection function is activated.
 - ◁ The main power supply is not interrupted. The product continues to be supplied with power.

5 Troubleshooting

4.9 Protecting the heating installation against frost

4.9.1 Frost protection function



Caution.

Risk of material damage due to frost.

The frost protection function cannot guarantee flow through the entire heating installation, which means that parts of the heating installation may freeze and therefore become damaged.

- ▶ During a period of frost, ensure that the heating installation remains in operation and that all rooms are sufficiently heated, even when you are away.

To keep the frost protection devices active, you should switch your product on and off using the controller, if one is provided.

If the heating flow temperature falls below 5 °C when the on/off button is on, the product comes into operation and heats the circulating water to approx. 30 °C on both the heating side and the hot water side (if available).

4.9.2 Draining the heating installation

When the unit is switched off for an extended period, frost protection can be guaranteed by completely draining the heating installation and the product.

- ▶ Consult a competent person about this.

5 Troubleshooting

5.1 Detecting and rectifying faults

- ▶ If faults occur or fault messages (F.XX) are displayed, proceed as set out in the tables in the appendix.
- ▶ If the product is not functioning correctly, contact a competent person.

5.2 Displaying the status codes

1. Press and at the same time.
 - ◁ S.XX is shown in the display, followed by the heating flow temperature and the internal system pressure.
2. Look up the meaning of the status codes.
Status codes – Overview (→ Page 17)
3. Press .
- ◁ The display switches to the basic display.

6 Care and maintenance

6.1 Maintenance

An annual inspection of the product carried out by a competent person is a prerequisite for ensuring that the product is permanently ready and safe for operation, reliable, and has a long working life.

6.2 Caring for the product



Caution.

Risk of material damage caused by unsuitable cleaning agents.

- ▶ Do not use sprays, scouring agents, detergents, solvents or cleaning agents that contain chlorine.

- ▶ Clean the casing with a damp cloth and a little solvent-free soap.

6.3 Reading maintenance messages

If the  symbol is shown in the display, the product requires maintenance work.

The product is not in fault mode but continues to operate.

- ▶ Consult a competent person about this.
- ▶ If the water pressure is flashing at the same time, simply add more heating water.

6.4 Checking the condensate drain pipework and tundish

The condensate drain pipework and tundish must always be penetrable.

- ▶ Regularly check the condensate drain pipework and tundish for faults and, particularly, for blockages.

You must not be able to see or feel any obstructions in the condensate drain pipework and tundish.

- ▶ If you notice a fault, have it rectified by a competent person.

7 Decommissioning

7.1 Temporarily decommissioning the product



Caution. **Risk of material damage due to frost.**

The frost protection and monitoring devices are only active while the unit is connected to the power mains and switched on via the on/off button, and when the gas isolator cock is open.

- ▶ Temporarily decommission the product only if no frost is expected.

- ▶ Press the on/off button.
 - ◀ The display goes out.
- ▶ When decommissioning the product for a prolonged period (e.g. holiday), close the gas isolator cock and also, for combination products, the cold water stop valve.

7.2 Permanently decommissioning the product

- ▶ Have a competent person permanently decommission the product.

8 Recycling and disposal

- ▶ The competent person who installed your product is responsible for the disposal of the packaging.



If the product is identified with this symbol:

- ▶ In this case, do not dispose of the product with the household waste.
- ▶ Instead, hand in the product to a collection centre for old electrical or electronic appliances.



If the product contains batteries that are marked with this symbol, these batteries may contain substances that are hazardous to human health and the environment.

- ▶ In this case, dispose of the batteries at a collection point for batteries.

9 Guarantee and customer service

9 Guarantee and customer service

9.1 Guarantee

- One year guarantee for ecoTEC sustain appliances

Vaillant provides this appliance with a parts and labour guarantee against defects that may occur within twelve months of the installation date.

- Registering with us

Registration is simple. Just complete the Guarantee Registration Card and return to Vaillant within 30 days of installation. Your details will then be automatically registered within the Vaillant scheme.

- Immediate help

If your Vaillant boiler develops a fault your first action should be to contact your installer, as his professional assessment is needed under the terms of our Guarantee. If you are unable to contact your installer, phone Vaillant Service Solutions:

Telephone: 0330 100 3461

9.2 Customer service

To ensure regular servicing, it is strongly recommended that arrangements are made for a Maintenance Agreement. Please contact Vaillant Service Solutions for further details:

Telephone: 0330 100 3461

Appendix

A Operator level – overview

Setting level	Values		Increment, select, explanation	Default setting
	Min.	Max.		
DHW mode				
Hot water temperature	Current value		< 35 = OFF	OFF
	35 °C	60 °C		
Heating mode				
Heating flow temperature	Current value		< 10 = OFF Underfloor heating = 35-50 Radiator = 35-80 Note The temperature range above 75 °C can only be set by a competent person.	OFF
	10 °C	80 °C		

B Status codes – Overview



Note

Since the code table is used for various products, some codes may not be visible for the product in question.

Codes that are not listed here can be found in the installation instructions.

Status code	Meaning
Displays in heating mode	
S.00	Heating mode: No requirement
S.02	Heating mode: Pump pre-run
S.03	Heating mode: Burner ignition
S.04	Heating mode: Burner on
S.06	Heating mode: Fan overrun
S.07	Heating mode: Pump overrun
S.08	Heating mode: Temporary shutdown after heating procedure
Displays in hot water handling mode	
S.10	Hot water handling mode: Requirement
S.14	DHW mode: Burner on
Display in Comfort mode with warm start or hot water handling mode with cylinder	
S.20	Hot water handling mode: Requirement
S.22	Hot water handling mode: Pump pre-run
S.24	DHW mode: Burner on
Other displays	
S.31	No heating demand: Summer mode, eBUS controller, waiting period
S.34	Frost protection active

Appendix

Status code	Meaning
S.46	Protection mode: Minimum load

C Troubleshooting and fault elimination

C.1 Troubleshooting

Symptom	Possible cause	Measure
The system pressure is flashing on the display	The system pressure is too low: < 0.05 MPa (< 0.50 bar). Low water pressure in the heating installation.	► Fill the heating installation. (→ Page 13)
	The system pressure is too high: > 0.3 MPa (> 3 bar).	► Wait until the excess heating water has flowed out through the expansion relief valve.
Product does not start up (no hot water, heating remains cold)	The gas isolator cock installed on-site and/or the gas isolator cock on the product is closed.	► Open both gas isolator cocks.
	The cold water stop valve is closed.	► Open the cold water stop valve.
	The product is switched off.	► Switch on the product. (→ Page 11)
	The heating flow temperature/hot water temperature has been set too low and/or the heating mode/hot water generation has been switched off.	1. Set the heating flow temperature. 2. Set the hot water temperature.
	There is air in the heating installation.	► Have a competent person purge the heating installation.
Hot water generation functioning correctly; heating does not start up	The external controller is not set correctly.	► Set the external controller correctly (→ Controller operating instructions).

C.2 Rectifying faults

Message	Possible cause	Measure
F.28 Ignition unsuccessful	After three unsuccessful ignition attempts, the product has switched to fault mode.	1. Check whether the gas isolator cock is open. 2. Press the reset button for longer than three seconds. 3. If you have been unable to eliminate the ignition fault after the fault clearance attempt, consult a competent person.



0020253095_01

0020253095_01 ■ 01.03.2017

Supplier

Vaillant Ltd.

Nottingham Road ■ Belper ■ Derbyshire ■ DE56 1JT

Telephone 0330 100 3461

info@vaillant.co.uk ■ www.vaillant.co.uk

© These instructions, or parts thereof, are protected by copyright and may be reproduced or distributed only with the manufacturer's written consent.

We reserve the right to make technical changes.