

For the operator

Operating instructions



ecoTEC plus

VU ..6/6-5 OVZ (H-GB)

GB, IE

Publisher/manufacture

Vaillant GmbH

Berghauser Str. 40 ■ D-42859 Remscheid
Tel. +49 21 91 18-0 ■ Fax +49 21 91 18-2810
info@vaillant.de ■ www.vaillant.de



Contents

Contents	7	Care and maintenance	13
1 Safety	3	7.1 Maintenance	13
1.1 Action-related warnings	3	7.2 Caring for the product	13
1.2 Intended use	3	7.3 Checking the condensate drain pipework and tundish	13
1.3 General safety information	4	7.4 Reading maintenance messages	13
2 Notes on the documentation	7	8 Decommissioning	13
2.1 Observing other applicable documents	7	8.1 Temporarily decommissioning the product	13
2.2 Storing documents	7	8.2 Permanently decommissioning the product	13
2.3 Applicability of the instructions	7	9 Recycling and disposal	13
3 Product description	7	10 Guarantee and customer service	14
3.1 Serial number	7	10.1 Guarantee	14
3.2 Information on the identification plate	7	10.2 Customer service	14
3.3 CE label	8	Appendix	15
3.4 Benchmark	8	A Operator level – overview	15
3.5 Design of the product	8	B Troubleshooting	15
3.6 Operator control panel	9		
3.7 Operating concept	9		
3.8 Basic display	10		
3.9 Operating levels	10		
3.10 Menu display	10		
4 Operation	10		
4.1 Opening the isolator devices	10		
4.2 Opening and closing the front flap	11		
4.3 Switching on the product	11		
4.4 Setting the language	11		
4.5 Setting the hot water temperature	11		
4.6 Setting the heating flow temperature	11		
4.7 Switching off heating mode (Summer mode)	12		
4.8 Protecting the heating installation against frost	12		
5 Detecting and rectifying faults	12		
6 Calling up (Live Monitor) status codes	12		

1 Safety

1.1 Action-related warnings

Classification of action-related warnings

The action-related warnings are classified in accordance with the severity of the possible danger using the following warning signs and signal words:

Warning symbols and signal words



Danger!

Imminent danger to life or risk of severe personal injury



Danger!

Risk of death from electric shock



Warning.

Risk of minor personal injury



Caution.

Risk of material or environmental damage

1.2 Intended use

There is a risk of injury or death to the user or others, or of damage to the product and other property in the event of improper use or use for which it is not intended.

The product is intended as a heat generator for closed cent-

ral heating installations and for hot water generation.

Intended use includes the following:

- observance of the operating instructions included for the product and any other system components
- compliance with all inspection and maintenance conditions listed in the instructions.

This product can be used by children aged from 8 years and above and persons with reduced physical, sensory or mental capabilities or lack of experience and knowledge if they have been given supervision or instruction concerning use of the product in a safe way and understand the hazards involved. Children must not play with the product. Cleaning and user maintenance work must not be carried out by children unless they are supervised.

Any other use that is not specified in these instructions, or use beyond that specified in this document shall be considered improper use. Any direct commercial or industrial use is also deemed to be improper.

Caution.

Improper use of any kind is prohibited.

1 Safety

1.3 General safety information

1.3.1 Installation by skilled tradesmen only

The installation, inspection, maintenance and repair of the product, as well as the gas ratio settings, must only be carried out by a competent person.

1.3.2 Danger caused by improper operation

Improper operation may present a danger to you and others, and cause material damage.

- ▶ Carefully read the enclosed instructions and all other applicable documents, particularly the "Safety" section and the warnings.
- ▶ Only carry out the activities for which instructions are provided in these operating instructions.

1.3.3 Risk of death from escaping gas

What to do if you smell gas in the building:

- ▶ Avoid rooms that smell of gas.
- ▶ If possible, open doors and windows fully and ensure adequate ventilation.
- ▶ Do not use naked flames (e.g. lighters, matches).
- ▶ Do not smoke.

- ▶ Do not use any electrical switches, mains plugs, door-bells, telephones or other communication systems in the building.
- ▶ If it is safe to do so, close the emergency control valve or the main isolator.
- ▶ If possible, close the gas isolator cock on the product.
- ▶ Warn other occupants in the building by yelling or banging on doors or walls.
- ▶ Leave the building immediately and ensure that others do not enter the building.
- ▶ Notify the gas supply company or the National Grid +44 (0) 800 111999 by telephone once you are outside of the building.

1.3.4 Risk of death due to a blocked or leaking flue gas pipe

What to do if you smell flue gas in the property:

- ▶ Open all accessible doors and windows fully to provide ventilation.
- ▶ Switch off the product.
- ▶ Inform a competent person.

1.3.5 Risk of death due to explosive and flammable materials

- ▶ Do not use or store explosive or flammable materials (e.g. petrol, paper, paint) in the installation room of the product.

1.3.6 Risk of death due to lack of safety devices

A lack of safety devices (e.g. expansion relief valve, expansion vessel) can lead to potentially fatal scalding and other injuries, e.g. due to explosions.

- ▶ Ask a competent person to explain how the safety devices work and where they are located.

1.3.7 Risk of death due to changes to the product or the product environment

- ▶ Never remove, bridge or block the safety devices.
- ▶ Do not tamper with any of the safety devices.
- ▶ Do not damage or remove any seals on components.
- ▶ Do not make any changes:
 - The product itself
 - to the gas, air, water and electricity supplies
 - to the entire flue gas installation

- to the entire condensate drain system
- to the expansion relief valve
- to the drain pipework
- to constructional conditions that may affect the operational reliability of the product

1.3.8 Risk of corrosion damage due to unsuitable combustion and room air

Sprays, solvents, chlorinated cleaning agents, paint, adhesives, ammonia compounds, dust or similar substances may lead to corrosion on the product and in the air/flue pipe.

- ▶ Ensure that the supply of combustion air is always free of fluorine, chlorine, sulphur, dust, etc.
- ▶ Ensure that no chemical substances are stored at the installation site.

1.3.9 Cabinet-type casing

Enclosing the product in cabinet-type casing requires compliance with the applicable design instructions.

- ▶ Do not fit the casing on the product yourself.
- ▶ If you require cabinet-type casing for the product, consult



1 Safety

an approved heating specialist company.

1.3.10 Risk of material damage caused by frost

- ▶ Ensure that the heating installation always remains in operation during freezing conditions and that all rooms are sufficiently heated.
- ▶ If you cannot ensure the operation, have a competent person drain the heating installation.

1.3.11 Risk of injury and material damage due to maintenance and repairs carried out incorrectly or not carried out at all

- ▶ Never attempt to carry out maintenance work or repairs on your product yourself.
- ▶ Faults and damage should be immediately rectified by a competent person.
- ▶ Adhere to the maintenance intervals specified.



Notes on the documentation 2

2 Notes on the documentation

2.1 Observing other applicable documents

- ▶ You must observe all operating instructions enclosed with the system components.

2.2 Storing documents

- ▶ Keep this manual and all other applicable documents safe for future use.

2.3 Applicability of the instructions

These instructions apply only to:

Product article number

	Article number	Gas Council Number
VU 126/6-5 OVZ (H-GB)	0010021220	41-694-13
VU 156/6-5 OVZ (H-GB)	0010021221	41-694-14
VU 186/6-5 OVZ (H-GB)	0010021222	41-694-15
VU 246/6-5 OVZ (H-GB)	0010021223	41-694-16
VU 306/6-5 OVZ (H-GB)	0010021224	41-694-17
VU 356/6-5 OVZ (H-GB)	0020015674	41-044-76

3 Product description



3.1 Serial number

The serial number is located on a plate behind the front flap. The plate is in a plastic fish plate. You can also display the serial number in the display.

3.2 Information on the identification plate

The identification plate is mounted on the underside of the product in the factory.

The identification plate keeps record of the country in which the product is to be installed.

Information on the identification plate	Meaning
	Barcode with serial number
Serial number	For quality control purposes; 3rd and 4th digits = year of production For quality control purposes; 5th and 6th digits = week of production For identification purposes; 7th to 16th digits = product article number For quality control purposes; 17th to 20th digits = place of manufacture
ecoTEC plus	Product designation
2H, G20 – 2 kPa (20 mbar)	Factory setting for type of gas and gas connection pressure
Cat.	Gas-fired boiler category
Condensing technology	Efficiency class of the boiler in accordance with EC Directive 92/42/EEC
Type: Xx3(x)	Permissible flue gas connections
PMS	Maximum water pressure in heating mode
PMW	Maximum water pressure in hot water handling mode
V/Hz	Electrical connection
W	Max. electrical power consumption
IP	Level of protection
	Heating mode
P _n	Nominal heat output range in heating mode

3 Product description

Information on the identification plate	Meaning
P _{nc}	Nominal heat output range in heating mode (condensing technology)
P	Nominal heat output range in hot water handling mode
Q _n	Nominal heating load range in heating mode
Q _{nw}	Nominal heating load range in hot water handling mode
T _{max.}	Max. flow temperature
NO _x	NO _x class for the product
Code (DSN)	Specific product code
	Read the instructions.
GC no.	Gas council number

3.3 CE label



The CE label shows that the products comply with the basic requirements of the applicable directives as stated on the identification plate.

The declaration of conformity can be viewed at the manufacturer's site.

3.4 Benchmark



Vaillant is a licensed member of the Benchmark Scheme which aims to improve the standards of installation and commissioning of domestic heating and hot water systems in the UK and to encourage regular servicing to optimise safety, efficiency and performance.

Benchmark is managed and promoted by the Heating and Hotwater Industry

Council. For more information visit www.benchmark.org.uk.

- ▶ Please ensure that the installer has fully completed the Benchmark Checklist on the inside back pages of the installation instructions supplied with the product and that you have signed it to say that you have received a full and clear explanation of its operation. The installer is legally required to complete a commissioning checklist as a means of complying with the appropriate Building Regulations (England and Wales).

All installations must be notified to Local Area Building Control either directly or through a Competent Persons Scheme. A Building Regulations Compliance Certificate will then be issued to the customer who should, on receipt, write the Notification Number on the Benchmark Checklist.

This product should be serviced regularly to optimise its safety, efficiency and performance. The service engineer should complete the relevant Service Record on the Benchmark Checklist after each service.

The Benchmark Checklist will be required in the event of any warranty.



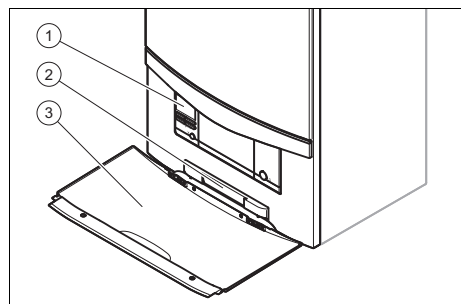

3.5 Design of the product



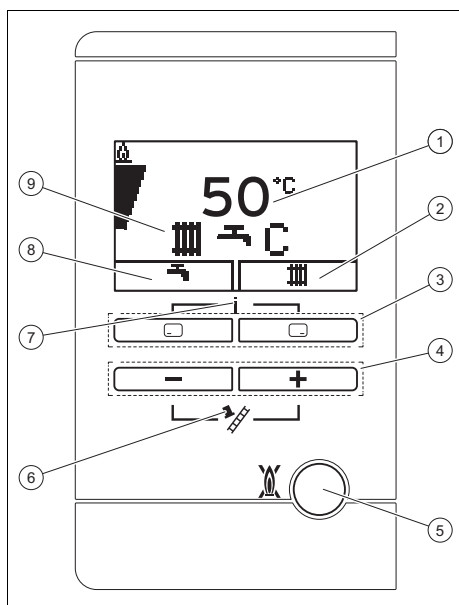

- | | | | |
|---|------------------|---|--------------------------------------|
| 1 | Control elements | 2 | Plate with serial number on the rear |
| | | 3 | Front flap |





3.6 Operator control panel





- | | |
|--|---|
| <p>1 Current heating flow temperature, operating mode, fault code or additional information</p> <p>2 Current assignment of the right-hand selection button</p> <p>3 Left- and right-hand selection buttons  </p> <p>4  and  button</p> | <p>5 Fault clearance key</p> <p>6 Maximum output (only used for Austria, Germany and Switzerland)</p> <p>7 Access to the menu for additional information</p> <p>8 Current assignment of the left-hand selection button</p> <p>9 Active operating status</p> |
|--|---|

3.6.1 Displayed symbols

Symbol	Meaning	Explanation
	Burner operating correctly	Burner on
	Current burner modulation rate	

Symbol	Meaning	Explanation
	Heating mode active	<ul style="list-style-type: none"> – Permanently on: Heating mode heat requirement – Flashing: Burner on in heating mode
	Maintenance required	Information on the maintenance message in the "Live Monitor"
	Summer mode active Heating mode is switched off	
	Burner anti-cycling time is active	To avoid the need for frequent switching on and off (increases the product's working life).
 F.XX	Fault in the product	Fault in the product. Appears instead of the basic display.

3.7 Operating concept

Operator control element	Meaning
	<ul style="list-style-type: none"> – Cancelling the activation of an operating mode – Cancelling a change to a set value – Move up to next selection level
	<ul style="list-style-type: none"> – Setting the heating flow temperature – Reading the system pressure – Activating the comfort mode – Activating the operating mode – Confirm setting – Move down to next selection level

4 Operation

Op-er-ator control element	Meaning
☐ + ☐ at the same time	Displaying the current product status
⊕ or ⊖	– Reducing or increasing the set value

The selection buttons have a soft key function, i.e. their function can change.

If, for example, you press the left-hand selection button ☐ in the basic display, the current function switches from  (hot water temperature) to **Back**.

Adjustable values flash in the display.

You must always confirm a change to a value. Only then is the new setting saved.

The display lights up when you switch the product on or press a button.

If you do not press any button within one minute, the display lighting goes out.

3.8 Basic display

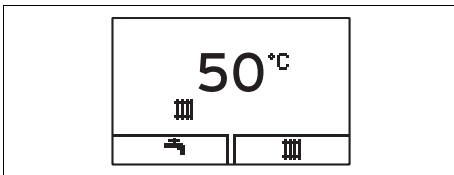

The basic display shows the current condition of the product. If you press a selection button, the activated function is displayed in the display.

The functions that are available depend on whether a controller is connected to the product.

You can switch back to the basic display by:

- Pressing ☐ to exit the selection levels
- Not pressing any button for longer than 15 minutes.

If there is an error message present, the basic displays switches to the error message.

3.9 Operating levels

The product has two operating levels.

- The end user level contains information and setting options that you require as the end user.
- The installer level is reserved for the competent person. It is protected by a code. Only competent persons may change any settings in the installer level.

3.10 Menu display

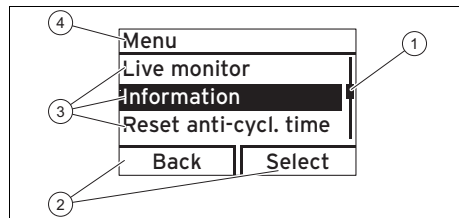

- | | | | |
|---|--|---|------------------------------|
| 1 | Scroll bar | 3 | Selection level list entries |
| 2 | Current assignment of the ☐ and ☐ buttons. | 4 | Name of the selection level |

You can find an overview of the menu structure in the appendix.

Operator level – overview (→ Page 15)

4 Operation

4.1 Opening the isolator devices

1. Ask the competent person who installed the product to explain to you where these isolator devices are located and how to handle them.
2. Open the gas isolator cock fully.
3. Check that the heating installation flow and return service valves are open, if such service valves are installed.

4.2 Opening and closing the front flap

1. Take hold of the recessed handle in the front flap.
2. Fold down the front flap.
3. Close the front flap after re-actuating the control elements.

4.3 Switching on the product

- ▶ Switch on the product via the main switch installed on-site.

4.4 Setting the language

1. Press and hold and at the same time.
2. Also briefly press .
3. Press and hold and until the display shows the language setting.
4. Select the required language by pressing or .
5. Confirm by pressing .
6. Once you have set the correct language, press again to confirm this.

4.5 Setting the hot water temperature

Applicability: Domestic hot water cylinder

Conditions: Water hardness: > 3.57 mol/m³

- ▶ Have a competent person take appropriate measures to protect against Legionella.
- ▶ Set the hot water temperature to a maximum of 50 °C.

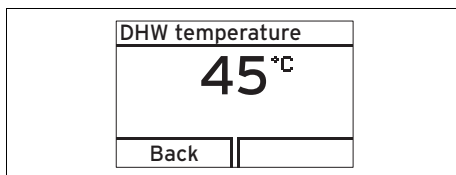

1. Press ().
 - ◁ The set hot water temperature flashes in the display.

Conditions: No controller connected

- ▶ Change the hot water temperature by pressing or .
- ▶ Confirm by pressing .

Conditions: Controller connected

- ▶ Use to set the maximum possible hot water temperature on the product.
- ▶ Confirm by pressing .
- ▶ Set the required hot water temperature on the controller (→ Controller operating instructions).

4.6 Setting the heating flow temperature

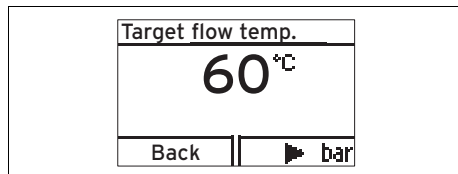

1. Press ().
 - ◁ The target value of the heating flow temperature appears on the display.



Note

The competent person may have adjusted the maximum possible temperature.

Conditions: No controller connected

- ▶ Use or to set the required heating flow temperature.
- ▶ Confirm by pressing .





Conditions: Controller connected

- ▶ Set the maximum possible heating flow temperature on the product.
- ▶ Confirm by pressing .
- ▶ Set the required heating flow temperature on the controller (→ Controller operating instructions).

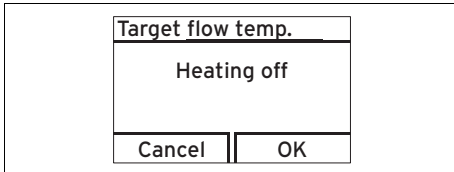
5 Detecting and rectifying faults

4.7 Switching off heating mode (Summer mode)



1. To switch off heating mode without switching off the hot water generation, press  (III).
 - ◁ The value of the heating flow temperature appears in the display.
2. Use the  button to set the heating flow temperature to **Heating off**.
3. Confirm by pressing .
 - ◁ Heating mode is switched off
 - ◁ The  symbol appears in the display.

4.8 Protecting the heating installation against frost

4.8.1 Frost protection function



Caution.

Risk of material damage due to frost.

The frost protection function cannot guarantee flow through the entire heating installation, which means that parts of the heating installation may freeze and therefore become damaged.

- ▶ During a period of frost, ensure that the heating installation remains in operation and that all rooms are sufficiently heated, even when you are away.



Note

To keep the frost protection devices active, you should switch your product on and off using the controller, if one is provided.

If the heating flow temperature falls below 5 °C when the on/off button is on, the product comes into operation and heats the circulating water to approx. 30 °C on both the heating side and the hot water side (if available).

4.8.2 Draining the heating installation



Another way to protect the heating installation and the product from frost for very long switch-off times is to drain them completely.

- ▶ Consult a competent person about this.

5 Detecting and rectifying faults

- ▶ If faults occur or fault messages are displayed (**F.xx**), proceed as set out in the table in the appendix. Troubleshooting (→ Page 15)
- ▶ If the product is not functioning correctly, contact a competent person.

6 Calling up (Live Monitor) status codes

1. Press  and  at the same time.
 - ◁ The menu is called up.
2. Navigate to the **Live monitor** menu item and press .
 - ◁ The current operating status (status code) is shown on the display.

7 Care and maintenance

7.1 Maintenance

An annual inspection of the product carried out by a competent person is a prerequisite for ensuring that the product is permanently ready and safe for operation, reliable, and has a long working life.

7.2 Caring for the product



Caution.
Risk of material damage caused by unsuitable cleaning agents.

- ▶ Do not use sprays, scouring agents, detergents, solvents or cleaning agents that contain chlorine.

- ▶ Clean the casing with a damp cloth and a little solvent-free soap.

7.3 Checking the condensate drain pipework and tundish

The condensate drain pipework and tundish must always be penetrable.

- ▶ Regularly check the condensate drain pipework and tundish for faults and, particularly, for blockages.

You must not be able to see or feel any obstructions in the condensate drain pipework and tundish.

- ▶ If you notice a fault, have it rectified by a competent person.

7.4 Reading maintenance messages

If the  symbol is shown in the display, the product requires maintenance work. The product is not in fault mode but continues to operate.

- ▶ Consult a competent person.

8 Decommissioning

8.1 Temporarily decommissioning the product



Caution.
Risk of material damage due to frost.

The frost protection and monitoring devices are only active while the unit is connected to the power mains and the gas isolator cock is open.

- ▶ Temporarily decommission the product only if no frost is expected.

- ▶ Switch off the product via the main switch installed on-site.
 - ◁ The display goes out.
- ▶ When decommissioning the product for an extended period (e.g. holiday), also close the gas isolator cock.

8.2 Permanently decommissioning the product

- ▶ Have a competent person permanently decommission the product.

9 Recycling and disposal

- ▶ The competent person who installed your product is responsible for the disposal of the packaging.



If the product is identified with this symbol:

- ▶ In this case, do not dispose of the product with the household waste.
- ▶ Instead, hand in the product to a collection centre for old electrical or electronic appliances.

10 Guarantee and customer service



If the product contains batteries that are marked with this symbol, these batteries may contain substances that are hazardous to human health and the environment.

- ▶ In this case, dispose of the batteries at a collection point for batteries.

10 Guarantee and customer service

10.1 Guarantee

- Two year guarantee for ecoTEC plus appliances

Vaillant provides this appliance with a parts and labour guarantee against defects that may occur within twenty-four months of the installation date. For the 2nd year of the guarantee to be valid an annual service must be carried out by a competent person approved at the time by the Health and Safety Executive one year after installation. The cost of this annual service is not included in the guarantee.

- Registering with us

Registration is simple. Just complete the Guarantee Registration Card and return to Vaillant within 30 days of installation. Your details will then be automatically registered within the Vaillant scheme.

- Immediate help

If your Vaillant boiler develops a fault your first action should be to contact your installer, as his professional assessment is needed under the terms of our Guarantee. If you are unable to contact your installer, phone Vaillant Service Solutions:

Telephone: 0330 100 3461

10.2 Customer service

To ensure regular servicing, it is strongly recommended that arrangements are made for a Maintenance Agreement. Please contact Vaillant Service Solutions for further details:

Telephone: 0330 100 3461

Appendix

A Operator level – overview

Setting level	Values		Unit	Increment, select	Default setting
	Min.	Max.			
Live Monitor →					
Status	Current value				
Information →					
Contact data	Phone number				
Serial number	Permanent value				
Display contrast	Current value			1	25
	15	40			
Reset anti-cycl. time →					
Current burner anti-cycling time	Current value		min		

B Troubleshooting

Fault	Cause	Measure
Product does not start up: – No hot water – Heating remains cold	The gas isolator cock installed on-site and/or the gas isolator cock on the product is closed.	Open both gas isolator cocks.
	The power supply in the building is disconnected.	Check the fuse in the building. The product switches on automatically when the power is restored.
	The product is switched off.	Switch on the product.
	The heating flow temperature is set too low or to the Heating off position, and/or the hot water temperature is set too low.	Set the heating flow and hot water temperature.
	There is air in the heating installation.	Have a competent person purge the heating installation.
	After three unsuccessful ignition attempts, the product switches to fault mode (fault message: F.28).	Press the fault clearance key for one second. The product makes another attempt to ignite the flame. If you have been unable to eliminate the ignition fault after three fault clearance attempts, consult a competent person.
	There is a fault in the flue gas route.	Have a competent person rectify the fault.

Appendix

Fault	Cause	Measure
Heating does not start.	The external controller is not set correctly.	Set the external controller correctly (→ Controller operating instructions).

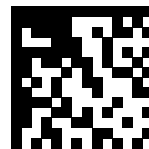

0020239012_01 ■ 10.10.2016

supplier

Vaillant Ltd.

Nottingham Road ■ Belper ■ Derbyshire ■ DE56 1JT

Telephone 0330 100 3461

info@vaillant.co.uk ■ www.vaillant.co.uk

© These instructions, or parts thereof, are protected by copyright and may be reproduced or distributed only with the manufacturer's written consent.

We reserve the right to make technical changes.