

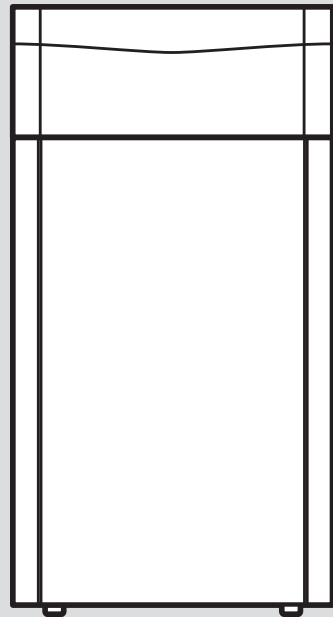

flexoTHERM exclusive

VWF 57 - 197/4, VWF 57 - 117/4 230V



Operating instructions

Contents

1	Safety	3	7	Care and maintenance	13
1.1	Intended use	3	7.1	Fulfilling requirements for the installation site	13
1.2	General safety information.....	3	7.2	Caring for the product.....	13
2	Notes on the documentation	6	7.3	Reading maintenance messages	13
2.1	Observing other applicable documents	6	7.4	Checking the system pressure	13
2.2	Storing documents.....	6	7.5	Checking the brine circuit's filling pressure.....	13
2.3	Validity of the instructions	6	8	Decommissioning	14
3	System overview	6	8.1	Temporarily decommissioning the product.....	14
3.1	Heat pump system design	6	8.2	Protecting the product against frost.....	14
3.2	Display of the energy consumption, energy yields and efficiencies	7	8.3	Permanently decommissioning the product.....	14
4	Product description	7	9	Recycling and disposal	14
4.1	Product design.....	7	9.1	Arranging disposal of the brine fluid	14
4.2	Serial number	7	9.2	Arranging disposal of refrigerant	14
4.3	Opening the front flap	7	10	Guarantee and customer service	14
4.4	CE marking	8	10.1	Guarantee.....	14
4.5	Safety devices	8	10.2	Customer service.....	15
5	Operation	9	Appendix	16	
5.1	Control panel	9	A	Overview of the end user level	16
5.2	Operating concept	10			
5.3	Basic display	10			
5.4	Menu display.....	11			
5.5	Operating levels.....	11			
5.6	Starting up the product	11			
5.7	Switching on the product	11			
5.8	Adjusting the target cylinder temperature	11			
5.9	Yield indicator	11			
5.10	Displaying the Live Monitor.....	12			
5.11	Displaying the building circuit pressure.....	12			
5.12	Displaying the environment circuit pressure	12			
5.13	Reading the operating statistics	12			
5.14	Setting the language.....	12			
6	Troubleshooting	12			

1 Safety

1.1 Intended use

There is a risk of injury or death to the user or others, or of damage to the product and other property in the event of improper use or use for which it is not intended.

The heat pump system is intended exclusively for domestic use.

The heat pump system is intended as a heat generator with cooling function for closed heating installations and for domestic hot water generation. Operating the pump outside the application limits results in the heat pump being switched off by the internal control and safety devices.

Cooling mode with radiator heating systems is not permitted since radiators do not have an adequate heat transfer surface area.

Intended use includes the following:

- observance of the operating instructions included for the product and any other installation components
- compliance with all inspection and maintenance conditions listed in the instructions.

This product can be used by children aged from 8 years and above and persons with reduced physical, sensory or mental capabilities or lack of experience and knowledge if they have been given supervision or instruction concerning use of the product in a safe way and understand the hazards involved. Children must not play with the product. Cleaning and user maintenance work must not be carried out by children unless they are supervised.

Any other use that is not specified in these instructions, or use beyond that specified in this document, shall be considered improper use. Any direct commercial or industrial use is also deemed to be improper.

Caution.

Improper use of any kind is prohibited.

1.2 General safety information

1.2.1 Danger caused by improper operation

Improper operation may present a danger to you and others, and cause material damage.

- ▶ Carefully read the enclosed instructions and all other applicable documents, particu-

larly the "Safety" section and the warnings.

- ▶ Only carry out the activities for which instructions are provided in these operating instructions.

1.2.2 Risk of death due to explosive and flammable materials

- ▶ Do not use the product in storage rooms that contain explosive or flammable substances (such as petrol, paper or paint).

1.2.3 Risk of death due to changes to the product or the product environment

- ▶ Never remove, bridge or block the safety devices.
- ▶ Do not tamper with any of the safety devices.
- ▶ Do not damage or remove any tamper-proof seals on components. Only authorised competent persons or customer services may modify sealed components.
- ▶ Do not make any changes:
 - The product itself
 - The product environment
 - The brine fluid, air and electricity supply lines
 - The drain pipework and expansion relief valve for the heat source circuit

- to constructional conditions that may affect the operational reliability of the product

1.2.4 Risk of chemical burns caused by brine fluid

The brine fluid ethylene glycol is harmful to health.

- ▶ Avoid contact with the skin and eyes.
- ▶ Always wear gloves and protective goggles.
- ▶ Do not inhale or swallow.
- ▶ Observe the safety data sheet that accompanies the brine fluid.

1.2.5 Risk of injury from freezing caused by touching refrigerant

The product is delivered with an operational filling of R410A refrigerant. Escaping refrigerant may cause freezing if the exit point is touched.

- ▶ If refrigerant escapes, do not touch any components of the product.
- ▶ Do not inhale any vapours or gases that escape from the refrigerant circuit as a result of leaks.
- ▶ Avoid skin or eye contact with the refrigerant.
- ▶ In the event of skin or eye contact with the refrigerant, seek medical advice.

1.2.6 Risk of injury and material damage due to maintenance and repairs carried out incorrectly or not carried out at all

- ▶ Never attempt to carry out maintenance work or repairs on your product yourself.
- ▶ Faults and damage should be immediately eliminated by a competent person.
- ▶ Adhere to the maintenance intervals specified.

1.2.7 Risk of material damage caused by frost

- ▶ Ensure that the heating installation always remains in operation during freezing conditions and that all rooms are sufficiently heated.
- ▶ If you cannot ensure the operation, have a competent person drain the heating installation.

1.2.8 Risk of environmental damage caused by refrigerant

The product contains a refrigerant that must not be allowed to escape into the atmosphere.

- ▶ Ensure that a competent person who is qualified to work with refrigerants services the product and, after decommissioning, recycles or disposes of it.

1.2.9 Avoid environmental damage caused by escaping refrigerant

The product contains the refrigerant R410A. The refrigerant must not be allowed to escape into the atmosphere. R410A is a fluorinated greenhouse gas covered by the Kyoto Protocol, with a GWP of 2088 (GWP = Global Warming Potential). If this gas escapes into the atmosphere, its impact is 2088 times greater than the natural greenhouse gas CO₂.

Before the product is disposed of, the refrigerant that is contained in it must be completely drained into a suitable vessel so that it can then be recycled or disposed of in accordance with regulations.

- ▶ Ensure that only officially certified competent persons with appropriate protective equipment carry out maintenance work on the refrigerant circuit or access it.
- ▶ Arrange for the refrigerant contained in the product to be recycled or disposed of by certified competent persons in accordance with regulations.

2 Notes on the documentation

2.1 Observing other applicable documents

- ▶ Always observe all operating instructions enclosed with the installation components.

2.2 Storing documents

- ▶ Store these instructions and all other applicable documents for further use.

2.3 Validity of the instructions

These instructions apply only to:

Validity: Great Britain OR Ireland

Product
VWF 57/4
VWF 87/4
VWF 117/4
VWF 157/4
VWF 197/4

Validity: Great Britain OR Ireland

Product
VWF 57/4 230 V
VWF 87/4 230 V
VWF 117/4 230 V

3 System overview

3.1 Heat pump system design

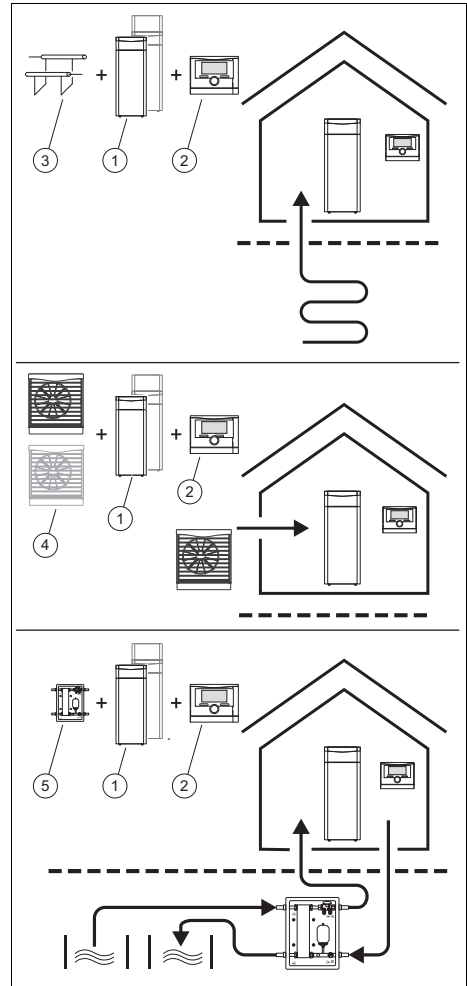

The heat pump system consists of the following components:

- Heat pump **(1)**
- System control **(2)** (from VRC 700)
- Outdoor temperature sensor with DCF receiver
- System sensor, if required
- With ground heat source: Ground collector **(3)**
- With air heat source (only products with 400 V): Air/brine collector(s) **(4)**

- With well water heat source: Ground water module (5)

There is an opportunity for active cooling to take place via circulation reversal for the heat sources air, ground and ground water.



Note

Approval from the water authorities is required for operation with active cooling using ground water as the heat source.

3.2 Display of the energy consumption, energy yields and efficiencies

The product, the system control and the app show approximate values for energy consumption, energy yields and efficiencies, which are extrapolated based on calculation algorithms.

The values that are displayed in the app may differ from the other display options due to staggered transfer intervals.

The determined values depend on:

- Installation and system of the heating installation
- User behaviour
- Seasonal weather effects
- Various tolerances of unit-internal components

The recording of the values only includes the product in the factory-delivered condition. Supplementary accessories, even if they are installed on the product, as well as any other components in the heating system and other external consumers, are not part of the data recording.

Deviations between the determined values and the actual values may be significant. The determined values are therefore not suitable for creating or comparing energy billing, for example.

When replacing the PCB, the values for energy consumption, energy yields and

efficiencies are reset in the heat pump's control panel.

4 Product description

4.1 Product design

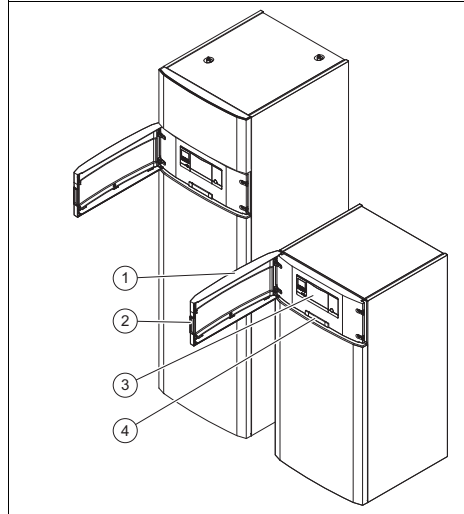

- | | | | |
|---|-----------------|---|---------------------------------|
| 1 | Front flap | 3 | Control elements |
| 2 | Recessed handle | 4 | Plate showing the serial number |

The product contains fluorinated greenhouse gases in a hermetically sealed device.

4.2 Serial number

The serial number is located on a plate behind the front flap. The 7th to 16th digits of the serial number form the article number.

4.3 Opening the front flap

1. Take hold of the recessed handle in the front flap on the left- or right-hand side.
2. Pull the recessed handle.

4.4 CE marking



The CE marking shows that the products comply with the basic requirements of the applicable directives as stated on the declaration of conformity.

The declaration of conformity can be viewed at the manufacturer's site.

4.5 Safety devices

4.5.1 Frost protection function

The frost protection function for the system is controlled via the system control. If the system control fails, the heat pump guarantees limited frost protection for the heating circuit.

4.5.2 Protection against low heating water pressure

This function continuously monitors the pressure of the heating water in order to prevent a possible loss of heating water.

4.5.3 Brine pressure detector

The brine pressure detector continuously monitors the fluid pressure in the environment circuit in order to prevent a possible shortage of fluid.

4.5.4 Freeze protection

This function prevents the evaporator from freezing when the heat source temperature drops below a certain value.

The outlet temperature of the heat source is constantly measured. If the outlet temperature of the heat source falls below a certain value, the compressor temporarily switches off and displays a status message. If this fault occurs three times in a row, it is switched off and a fault message is displayed.

4.5.5 Pump- and valve-blocking protection system

This function prevents the pumps for heating water and brine and all diverter valves from sticking. The pumps and the valves, which were out of operation for 23 hours, are switched on for 10 - 20 seconds, one after the other.

4.5.6 High-pressure pressure switch in the refrigerant circuit

The high-pressure pressure switch shuts down the heat pump if the pressure in the refrigerant circuit is too high. Following a waiting period, the heat pump attempts to start once more. After three failed start attempts in succession, a fault message is displayed.

- Max. refrigerant circuit pressure: 4.60 MPa (g) (46.00 bar (g))
- Waiting period: 5 minutes (after the first occurrence)
- Waiting period: 30 minutes (after the second and every further occurrence)

The fault counter is reset if both of the following conditions are met:

- Heat requirement without switching off prematurely
- 60 minutes of uninterrupted operation

4.5.7 Hot gas thermostat in the refrigerant circuit

The hot gas thermostat shuts down the heat pump if the temperature in the refrigerant circuit is too high. Following a waiting period, the heat pump attempts to start once more. After three failed start attempts in succession, a fault message is displayed.

- Max. refrigerant circuit temperature: 135 °C
- Waiting period: 5 minutes (after the first occurrence)
- Waiting period: 30 minutes

(after the second and every further occurrence)

The fault counter is reset if both of the following conditions are met:

- Heat requirement without switching off prematurely
- 60 minutes of uninterrupted operation

4.5.8 Safety cut-out (SCO) in the heating circuit





If the temperature in the heating circuit of the internal electric back-up heater exceeds the maximum temperature, the safety cut-out shuts down the electric back-up heater as a securing measure. Following a waiting period, another attempt is made to start the electric back-up heater. A fault message is displayed that can only be reset by pressing the Reset button or by switching the heat pump off and on again.

- Max. heating circuit temperature: 85 °C

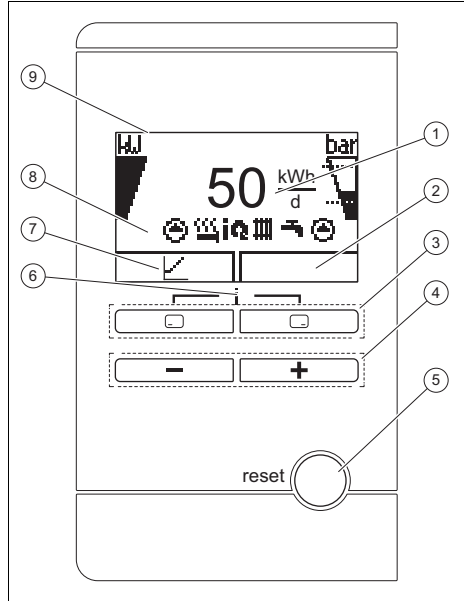





5 Operation



5.1 Control panel



- | | | | |
|---|--|---|---|
| 1 | Displays the daily environmental energy yield | 6 | Access to the menu for additional information (press both selection buttons at the same time) |
| 2 | Display of the current assignment of the right-hand selection button | 7 | Display of the current configuration of the left-hand selection button |
| 3 | Left- and right-hand selection buttons   | 8 | Displays the symbols for the current operating mode of the heat pump |
| 4 |  and  button | 9 | Display |
| 5 | Reset button (restarts the heat pump and system control) | | |

5.2 Operating concept

Control element	Function
	<ul style="list-style-type: none"> - Displaying the environmental energy yield in heating mode, domestic hot water mode and cooling mode - Cancelling a change to a set value - Going one selection level higher
	<ul style="list-style-type: none"> - Confirm the set value - Going one selection level lower
 +  at the same time	<ul style="list-style-type: none"> - Calling up the menu
 or 	<ul style="list-style-type: none"> - Reducing or increasing the set value - Scrolling through menu entries







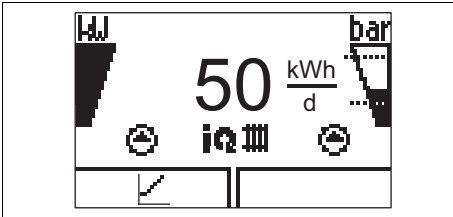

The current function of the  and  selection buttons is shown on the display. Adjustable values are always displayed as flashing.

You must always confirm a change to a value. Only then is the new setting saved. You can press  to cancel a procedure.

5.3 Basic display



Symbol	Meaning	Explanation
	Compressor	<ul style="list-style-type: none"> - Filled: Compressor in operation - Not filled: Compressor not in operation

Symbol	Meaning	Explanation
	Current filling pressure of the heating system The dashed lines show the permitted range.	<ul style="list-style-type: none"> - Permanently on: Filling pressure in the permitted range. - Flashing: Filling pressure outside the permitted range.
	Pumps	<ul style="list-style-type: none"> - Left continuously on: Brine pump in operation - Right continuously on: Heating pump in operation
	Auxiliary electric heating	<ul style="list-style-type: none"> - Flashing: Auxiliary electric heating in operation - : Auxiliary electric heating active for heating mode - : Auxiliary electric heating active for hot water handling mode
	Green iQ mode	<ul style="list-style-type: none"> - Product equipped with energy-saving technology
	Heating mode	<ul style="list-style-type: none"> - Continuously on: Heating mode active
	Cooling mode	<ul style="list-style-type: none"> - Continuously on: Cooling mode active (active or passive)
	Hot water generation	<ul style="list-style-type: none"> - Continuously on: Hot water handling mode active

Symbol	Meaning	Explanation
 F.XXX	Fault in the product	– Appears instead of the basic display, may be an explanatory plain text display

The basic display shows you the product's operating mode. If you press a selection button, the activated function is displayed in the display.

You can switch back to the basic display by:

- Pressing  to exit the selection levels
- Or not pressing any button for longer than 15 minutes.

If there is an error message present, the basic displays switches to the error message.

5.4 Menu display

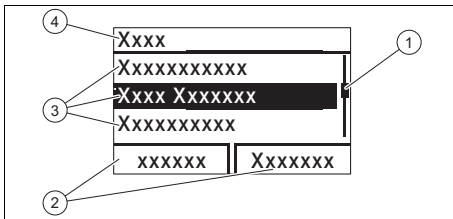

- | | | | |
|---|---|---|------------------------------|
| 1 | Scroll bar | 3 | Selection level list entries |
| 2 | Current assignment of the selection buttons | 4 | Selection level |

You can find an overview of the menu structure in the appendix.

5.5 Operating levels

The product has two operating levels.

The operating level for the end user shows the information and offers setting options that do not require any special prior knowledge.

The operating level for the competent person is protected by a code.

Overview of the end user level
(→ Appendix A)

5.6 Starting up the product

- ▶ Only start up the product once the casing has been completely closed.

5.7 Switching on the product

- ▶ Use the partition that is installed on-site (e.g. fuses or power switches) to switch on the product.

5.8 Adjusting the target cylinder temperature

In order to achieve energy-efficient domestic hot water generation predominantly from the energy extracted from the environment, the factory setting for the desired domestic hot water temperature must be adjusted on the system control.

- ▶ To do this, adjust the target cylinder temperatures (**Desired DHW circuit temperature**) to between 50 and 55 °C, for example.

◁ Depending on the source of energy obtained from the environment, domestic hot water outlet temperatures of between 55 and 62 °C are reached.



Note

Make sure your installation's anti-legionella function is working correctly. If you decrease the cylinder temperature, the risk of legionella spreading increases. Activate the anti-legionella time programme in the system control and configure the settings.

5.9 Yield indicator

Displays the environmental energy yield as a cumulative value for a time period of a day, a month and the total for the heating, domestic hot water generation and cooling operating modes.

Displays the working figure for a time period of a month and the total for the heating and domestic hot water generation operating modes. The working figure is

the ratio of thermal energy generated to the operating current used. Monthly values may vary considerably since, for example, in the summer only domestic hot water generation is used. A large number of factors influence this estimate, e.g. the type of heating installation (direct heating mode = low flow temperature or indirect heating mode via buffer cylinder = high flow temperature). This figure may therefore deviate by up to 20%.

The working figures only record the power consumption of internal components, not of external components such as external heating circuit pumps, valves, etc.

5.10 Displaying the Live Monitor

Menu → Live Monitor

You can use the Live Monitor to view the current status of the product.

5.11 Displaying the building circuit pressure

Menu → Live Monitor → Building circuit pressure

You can use this function to display the current filling pressure in the heating installation.

5.12 Displaying the environment circuit pressure

Menu → Live Monitor → Environment circuit pressure

You can use this function to display the current filling pressure in the environment circuit.

5.13 Reading the operating statistics

Menu → Information → Heating op. hours

Menu → Information → DHW operating hours

Menu → Information → Cooling op. hours

Menu → Information → Total operating hours

You can use this function to display the operating hours for heating mode, for domestic hot water mode, for cooling mode and for overall operation.

5.14 Setting the language

Menu → Default settings → Language

You can use this function to set the desired language.

6 Troubleshooting



Note

If the heat pump has switched off automatically due to a fault, the system control can be used to activate a limp home mode with the electric back-up heater.

If several faults occur at the same time, the display shows the corresponding fault messages for two seconds each in alternation.

F.714 Environment circuit: Pressure too low

If the filling pressure falls below the minimum pressure, the heat pump will be switched off automatically.

- Minimum brine fluid pressure:
≥ 0.05 MPa (≥ 0.50 bar)
- Min. brine fluid operating pressure:
≥ 0.07 MPa (≥ 0.70 bar)
- ▶ Inform your competent person so that he can top up the brine fluid.

F.723 Building circuit: Pressure too low

If the filling pressure falls below the minimum pressure, the heat pump will be switched off automatically.

- Min. heating circuit pressure:
≥ 0.05 MPa (≥ 0.50 bar)
- Min. heating circuit operating pressure:
≥ 0.07 MPa (≥ 0.70 bar)

- ▶ Inform your competent person so that he can top up the heating water.

F.1120 immersion heater: Phase failure

The product has an internal circuit breaker which switches off the heat pump in the event of short circuits or the failure of one (product with 230 V power supply) or several (product with 400 V power supply) current-carrying phases.

If the electric back-up heater is defective, the Anti-legionella function is not guaranteed.

- ▶ Inform your competent person so that they can eliminate the fault and reset the internal circuit breaker.

7 Care and maintenance

7.1 Fulfilling requirements for the installation site

The installation site must be dry and frost-proof throughout.

Condition: Outdoor air heat source

The air/brine collector is designed to be operated with outdoor air. The air intake and blow-off route of the outdoor unit must be kept clear at all times in order to guarantee that the air can flow unhindered and as intended. Vegetation and, in winter, snowfall, must be cleared.

You are not permitted to make any subsequent structural alterations which may result in a reduced room volume or a change to the temperature at the installation site.

7.2 Caring for the product

- ▶ Clean the casing with a damp cloth and a little solvent-free soap.
- ▶ Do not use sprays, scouring agents, detergents, solvents or cleaning agents that contain chlorine.

7.3 Reading maintenance messages

If the  symbol is shown in the display, the product requires maintenance work or the product is in restricted mode (comfort protection). The product is not in fault mode; it continues to operate.

Regardless of maintenance messages appearing on the display, it is advisable to have a competent person carry out an inspection every year and maintenance every two years in order to keep the product in good working order.

- ▶ Consult a competent person.

Condition: Lhm. 37 is displayed

The product is in Comfort protection mode. The product has detected a permanent fault and continues to run with restricted comfort.

7.4 Checking the system pressure

1. Check the filling pressure of the heating installation every day for a week after initial start-up and maintenance work, and then twice a year.
 - Min. heating circuit operating pressure: ≥ 0.07 MPa (≥ 0.70 bar)
2. Inform your competent person so that he can add heating water and increase the filling pressure.

7.5 Checking the brine circuit's filling pressure

1. Check the brine circuit's filling pressure at regular intervals. Read the brine circuit's filling pressure in the heat pump's display.
 - Brine fluid operating pressure range: 0.07 to 0.20 MPa (0.70 to 2.00 bar)
2. Inform your competent person so that he can add brine and increase the filling pressure.

8 Decommissioning

8.1 Temporarily decommissioning the product

- ▶ Use the partition that is installed on-site (e.g. fuses or power switches) to disconnect the product from the power supply.

8.2 Protecting the product against frost

- ▶ Observe the requirements for the installation site for the product.
(→ Section 7.1)

8.3 Permanently decommissioning the product

- ▶ Have a competent person permanently decommission and dispose of the product.

9 Recycling and disposal

Validity: Great Britain OR Ireland

Disposing of the packaging

- ▶ The competent person who installed your product is responsible for the disposal of the packaging.

Disposing of the product



■ If the product is labelled with this mark:

- ▶ In this case, do not dispose of the product with the household waste.
- ▶ Instead, hand in the product to a collection centre for waste electrical or electronic equipment.

Disposing of batteries



■ If the product contains batteries that are labelled with this mark:

- ▶ In this case, dispose of the batteries at a collection point for batteries.

◁ **Prerequisite:** The batteries can be removed from the product without causing any destruction. Otherwise, the batteries are disposed of together with the product.

- ▶ In accordance with the legal regulations, used batteries must be returned since batteries may contain substances that are harmful to health and the environment.

9.1 Arranging disposal of the brine fluid

The product is filled with the brine fluid ethylene glycol, although when using ground as the heat source, aqueous solutions of propylene glycol may also be used as an alternative. Ethylene glycol is harmful to health.

- ▶ Brine fluid must only be disposed of by a qualified competent person.

9.2 Arranging disposal of refrigerant

The product is filled with R410A refrigerant which must not be released into the atmosphere.

- ▶ Refrigerant must only be disposed of by a qualified competent person who holds a refrigerant-handling certificate.

10 Guarantee and customer service

10.1 Guarantee

Validity: Great Britain OR Ireland

Vaillant provides a full parts and labour guarantee for this appliance for the duration as shown on the enclosed registration card which must be fully completed and returned within 30 days of installation. All appliances must be installed by a suitably competent person fully conversant and in accordance with all current regulations applicable to the appliance type installation. In the case of gas appliances the Gas

Safety (Installation and Use) Regulations 1998, and the manufacturer's instructions. In the UK competent persons approved at the time by the Health and Safety Executive undertake the work in compliance with safe and satisfactory standards. Installers should also be fully conversant with and competent with all necessary electrical and building regulations that may apply to the installation.

In addition all unvented domestic hot water cylinders must be installed by a competent person to the prevailing building regulations at the time of installation (G3). All appliances shall be fully commissioned in accordance with our installation manual and Benchmark commissioning check list (this will be included within the installation manual). These must be signed and given to the user for safe keeping during the hand over process. Installers should also at this time advise the user of the annual servicing requirements and advise of appropriate service agreement.

Terms and conditions do apply to the guarantee, details of which can be found on the registration card included with this appliance. In order to qualify for guarantee after one year the appliance must be serviced in accordance with our installation manual servicing instructions. The benchmark service history should be completed. Note - all costs associated with this service are excluded from this guarantee.

Failure to install and commission this appliance in compliance with the manufacturer's instructions will invalidate the guarantee (this does not affect the customer's statutory rights).

10.2 Customer service

Validity: Great Britain OR Ireland

For contact details for our customer service department, you can write to the address that is provided on the back page, or you can visit www.vaillant.co.uk.

Appendix

A Overview of the end user level

Setting level	Values		Unit	Increment, se- lect	Factory setting	Setting
	Min.	Max.				
Yield indicator →						
Energy yield: Day, Heating	Cumulative value		kWh			
Energy yield: Day, Domestic hot water	Cumulative value		kWh			
Energy yield: Day, Cooling	Cumulative value		kWh			
Energy yield: Month, Heating	Cumulative value		kWh			
Working figure: Month, Heating	Cumulative value					
Energy yield: Total, Heating	Cumulative value		kWh			
Working figure: Total, Heating	Cumulative value					
Energy yield: Month, Domestic hot water	Cumulative value		kWh			
Working figure: Month, Domestic hot water	Cumulative value					
Energy yield: Total, Domestic hot water	Cumulative value		kWh			
Working figure: Total, Domestic hot water	Cumulative value					
Live Monitor →						
Current status message(s)	Current value					
Building circuit pressure	Current value		bar			
Environment circuit pressure	Current value		bar			
Switch-on delay	Current value		min			
Target flow temp.	Current value		°C			
Current flow temp.	Current value		°C			
Energy integral	Current value		°min			
Environment circuit inlet temperature	Current value		°C			
Environment circuit outlet temperature	Current value		°C			
Cooling capacity	Current value		kW			

Setting level	Values		Unit	Increment, select	Factory setting	Setting
	Min.	Max.				
Electrical power consumption	Current value		kW	Total power consumption of the heat pump without any external components connected (as supplied).		
Immersion heater power	Current value		kW			
Information →						
Contact details	Phone number					
Serial number	Permanent value					
Operating hours total	Cumulative value		h			
Hours heating	Cumulative value		h			
DHW operating hours	Cumulative value		h			
Cooling op. hours	Cumulative value		h			
Default settings →						
Language	Current language			Languages available for selection	02 English	
Display contrast	Current value			1	25	
	15	40				
Resets →						
Reset anti-cycl. time	-			Cancel reset anti-cycl. time?	Yes/No	

Supplier

Vaillant Ltd.

Nottingham Road ■ Belper ■ Derbyshire ■ DE56 1JT

Telephone 0330 100 3143

info@vaillant.co.uk ■ www.vaillant.co.uk



0020213396_05

Publisher/manufacturer

Vaillant GmbH

Berghauser Str. 40 ■ D-42859 Remscheid

Tel. +49 2191 18 0 ■ Fax +49 2191 18 2810

info@vaillant.de ■ www.vaillant.de

© These instructions, or parts thereof, are protected by copyright and may be reproduced or distributed only with the manufacturer's written consent.

Subject to technical modifications.